

marantz®

Model DV6001 User Guide

Super Audio CD/DVD Player

CLASS 1 LASER PRODUCT
LUOKAN 1 LASERLAITE
KLASS 1 LASERAPPARAT



CONGRATULATIONS ON YOUR PURCHASE OF THIS FINE MARANTZ PRODUCT.

MARANTZ is on the leading edge of DVD research for consumer products and this unit incorporates the latest technological developments.

We are sure you will be fully satisfied with the DVD player.

Thank you for your support.

Please read through these operating instructions so you will know how to operate your model properly. After you have finished reading the instructions, put them away in a safe place for future reference.

Copy protection

Many DVD discs are encoded with copy protection. Because of this, you should only connect your DVD player directly to your TV, not to a VCR. Connecting to a VCR results in a distorted picture from copy-protected DVD discs.

This product incorporates copyright protection technology that is protected by methods claims of certain U.S. patents and other intellectual property rights owned by Macrovision Corporation and other rights owners.

Use of this copyright protection technology must be authorized by Macrovision Corporation, and is intended for home and other limited viewing uses only unless otherwise authorized by Macrovision Corporation.

Reverse engineering or disassembly is prohibited.

Operating Environment

Operating environment temperature and humidity:
+5°C to +35°C (+41°F to +95°F); less than 85%RH
(cooling vents not blocked)

Do not install in the following locations

- Location exposed to direct sunlight or strong artificial light
- Location exposed to high humidity, or poorly ventilated location

This product is for general household purposes. Any failure due to use for other than household purposes (such as long-term use for business purposes in a restaurant or use in a car or ship) and which requires repair will be charged for even during the warranty period.

NOTE:

Changes or modifications not expressly approved by the party responsible for compliance could void the user's authority to operate the equipment.

WARNING

TO REDUCE THE RISK OF FIRE OR ELECTRIC SHOCK,
DO NOT EXPOSE THIS APPLIANCE TO RAIN OR MOISTURE.

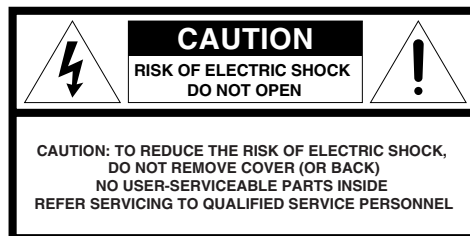

The lightning flash with arrowhead symbol, within an equilateral triangle, is intended to alert the user to the presence of uninsulated "dangerous voltage" within the product's enclosure that may be of sufficient magnitude to constitute a risk of electric shock to persons.



The exclamation point within an equilateral triangle is intended to alert the user to the presence of important operating and maintenance (servicing) instructions in the literature accompanying the appliance.

CAUTION:
TO PREVENT ELECTRIC SHOCK, MATCH WIDE
BLADE OF PLUG TO WIDE SLOT, FULLY INSERT.

ATTENTION:
POUR ÉVITER LES CHOCS ÉLECTRIQUES,
INTRODUIRE LA LAME LA PLUS LARGE DE LA FICHE DANS
LA BORNE CORRESPONDANTE DE LA PRISE ET POUSSER
JUSQU'AU FOND.

LASER SAFETY

This unit employs a laser. Only a qualified service person should remove the cover or attempt to service this device, due to possible eye injury.



CAUTION :
USE OF CONTROLS OR ADJUSTMENTS OR
PERFORMANCE OF PROCEDURE OTHER THAN
THOSE SPECIFIED HEREIN MAY RESULT IN
HAZARDOUS RADIATION EXPOSURE.

CAUTION
VISIBLE AND INVISIBLE LASER RADIATION WHEN OPEN AVOID
EXPOSURE TO BEAM (WARNING LOCATION: INSIDE ON LASER
COVERSHIELD)

IMPORTANT SAFETY INSTRUCTIONS

READ BEFORE OPERATING EQUIPMENT (for U. S. A only)

This product was designed and manufactured to meet strict quality and safety standards. There are, however, some installation and operation precautions which you should be particularly aware of.

1. Read Instructions – All the safety and operating instructions should be read before the product is operated.
2. Retain Instructions – The safety and operating instructions should be retained for future reference.
3. Heed Warnings – All warnings on the product and in the operating instructions should be adhered to.
4. Follow Instructions – All operating and use instructions should be followed.
5. Cleaning – Unplug this product from the wall outlet before cleaning. Do not use liquid cleaners or aerosol cleaners. Use a damp cloth for cleaning.
6. Attachments – Do not use attachments not recommended by the product manufacturer as they may cause hazards.
7. Water and Moisture – Do not use this product near water-for example, near a bath tub, wash bowl, kitchen sink, or laundry tub, in a wet basement, or near a swimming pool, and the like.
8. Accessories – Do not place this product on an unstable cart, stand, tripod, bracket, or table. The product may fall, causing serious injury to a child or adult, and serious damage to the product. Use only with a cart, stand, tripod, bracket, or table recommended by the manufacturer, or sold with the product. Any mounting of the product should follow the manufacturer's instructions, and should use a mounting accessory recommended by the manufacturer.
9. CART – A product and cart combination should be moved with care. Quick stops, excessive force, and uneven surfaces may cause the product and cart combination to overturn. 
10. Ventilation – Slots and openings in the cabinet are provided for ventilation and to ensure reliable operation of the product and to protect it from overheating, and these openings must not be blocked or covered. The openings should never be blocked by placing the product on a bed, sofa, rug, or other similar surface. This product should not be placed in a built-in installation such as a book case or rack unless proper ventilation is provided or the manufacturer's instructions have been adhered to.
11. Power Sources – This product should be operated only from the type of power source indicated on the marking label. If you are not sure of the type of power supply to your home, consult your product dealer or local power company. For products intended to operate from battery power, or other sources, refer to the operating instructions.
12. Grounding or Polarization – This product may be equipped with a polarized alternating-current line plug (a plug having one blade wider than the other). This plug will fit into the power outlet only one way. This is a safety feature. If you are unable to insert the plug fully into the outlet, try reversing the plug. If the plug should still fail to fit, contact your electrician to replace your obsolete outlet. Do not defeat the safety purpose of the polarized plug. 
13. Power-Cord Protection – Power-supply cords should be routed so that they are not likely to be walked on or pinched by items placed upon or against them, paying particular attention to cords at plugs, convenience receptacles, and the point where they exit from the product.
14. Protective Attachment Plug – The product is equipped with an attachment plug having overload protection. This is a safety feature. See Instruction Manual for replacement or resetting of protective device. If replacement of the plug is required, be sure the service technician has used a replacement plug specified by the manufacturer that has the same overload protection as the original plug.
15. Outdoor Antenna Grounding – If an outside antenna or cable system is connected to the product, be sure the antenna or cable system is grounded so as to provide some protection against voltage surges and built-up static charges. Article 810 of the National Electrical Code, ANSI/NFPA 70, provides information with regard to proper grounding of the mast and supporting structure, grounding of the lead-in wire to an antenna discharge unit, size of grounding conductors, location of antenna-discharge unit, connection to grounding electrodes, and requirements for the grounding electrode. See Figure 1.
16. Lightning – For added protection for this product during a lightning storm, or when it is left unattended and unused for long periods of time, unplug it from the wall outlet and disconnect the antenna or cable system. This will prevent damage to the product due to lightning and power-line surges.

17. Power Lines – An outside antenna system should not be located in the vicinity of overhead power lines or other electric light or power circuits, or where it can fall into such power lines or circuits. When installing an outside antenna system, extreme care should be taken to keep from touching such power lines or circuits as contact with them might be fatal.
18. Overloading – Do not overload wall outlets, extension cords, or integral convenience receptacles as this can result in a risk of fire or electric shock.
19. Object and Liquid Entry – Never push objects of any kind into this product through openings as they may touch dangerous voltage points or short-out parts that could result in a fire or electric shock. Never spill liquid of any kind on the product.
20. Servicing – Do not attempt to service this product yourself as opening or removing covers may expose you to dangerous voltage or other hazards. Refer all servicing to qualified service personnel.
21. Damage Requiring Service – Unplug this product from the wall outlet and refer servicing to qualified service personnel under the following conditions:
 - a. When the power-supply cord or plug is damaged.
 - b. If liquid has been spilled, or objects have fallen into the product.
 - c. If the product has been exposed to rain or water.
 - d. If the product does not operate normally by following the operating instructions. Adjust only those controls that are covered by the operating instructions as an improper adjustment of other controls may result in damage and will often require extensive work by a qualified technician to restore the product to its normal operation.
 - e. If the product has been dropped or damaged in any way, and
 - f. When the product exhibits a distinct change in performance – this indicates a need for service.
22. Replacement Parts - When replacement parts are required, be sure the service technician has used replacement parts specified by the manufacturer or have the same characteristics as the original part. Unauthorized substitutions may result in fire, electric shock, or other hazards.
23. Safety Check – Upon completion of any service or repairs to this product, ask the service technician to perform safety checks to determine that the product is in proper operating condition.
24. Wall or Ceiling Mounting – The product should be mounted to a wall or ceiling only as recommended by the manufacturer.
25. Heat – The product should be situated away from heat sources such as radiators, heat registers, stoves, or other products (including amplifiers) that produce heat.

FIGURE 1
EXAMPLE OF ANTENNA GROUNDING AS PER
NATIONAL ELECTRICAL CODE, ANSI/NFPA 70

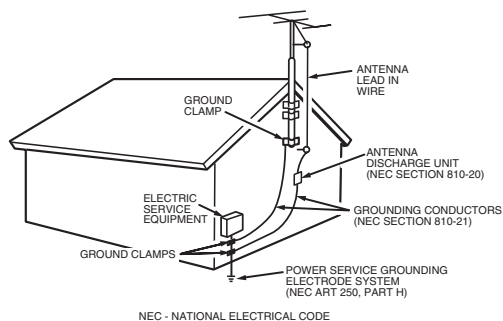

This Class B digital apparatus complies with Canadian ICES-003.

Cet appareil numérique de la Classe B est conforme à la norme NMB-003 du Canada.

FCC NOTE (for U. S. A only):

This equipment has been tested and found to comply with the limits for a Class B digital device, pursuant to Part 15 of the FCC rules. These limits are designed to provide reasonable protection against harmful interference in a residential installation. This equipment generates, uses and can radiate radio frequency energy and, if not installed and used in accordance with the instructions, may cause harmful interference to radio or television reception, which can be determined by turning the equipment off and on, the user is encouraged to try to correct the interference by one or more of the following measures.

- Reorient or relocate the receiving antenna.
- Increase the separation between the equipment and receiver.
- Connect this equipment into an outlet on a circuit different from that to which the receiver is connected.
- Consult the dealer or an experienced radio/TV technician for help.

NOTE: Changes or modifications may cause this unit to fail to comply with Part 15 of the FCC Rules and may void the user's authority to operate the equipment.

This Class B digital apparatus complies with Canadian ICES-003.

Cet appareil numérique de la Classe B est conforme à la norme NMB-003 du Canada.

This product satisfies FCC regulations when shielded cables and connectors are used to connect the unit to other equipment. To prevent electromagnetic interference with electric appliances, such as radios and televisions, use shielded cables and connectors for connections.

CE marking (for Europe only)

 This product is in conformity with the EMC directive and low-voltage directive.

WARNINGS

- Do not expose the equipment to rain or moisture.
- Do not remove the cover from the equipment.
- Do not insert anything into the equipment through the ventilation holes.
- Do not handle the mains lead with wet hands.
- Do not cover the ventilation with any items such as tablecloths, newspapers, curtains, etc.
- No naked flame sources, such as lighted candles, should be placed on the equipment.
- When disposing of used batteries, please comply with governmental regulations or environmental public instruction's rules that apply in your country or area.

- Do not place anything about 0.1 meter above the top panel.
- Make a space of about 0.1 meter around the unit.
- No objects filled with liquids, such as vases, shall be placed on the apparatus.
- When the switch is in the OFF position, the equipment is not completely switched off from MAINS.
- The equipment shall be installed near the power supply so that the power supply is easily accessible.

WARRANTY

For warranty information, contact your local Marantz distributor.

RETAIN YOUR PURCHASE RECEIPT

Your purchase receipt is your permanent record of a valuable purchase. It should be kept in a safe place to be referred to as necessary for insurance purposes of when corresponding with Marantz.

IMPORTANT

When seeking warranty service, it is the responsibility of the consumer to establish proof and date of purchase. Your purchase receipt or invoice is adequate for such proof.

FOR U.K. ONLY

This undertaking is in addition to a consumer's statutory rights and does not affect those rights in any way.

Disc Storage

Be careful not to harm the disc because the data on these discs is highly vulnerable to the environment.

- Do not keep under direct sunlight.
- Keep in a cool ventilated area.
- Store vertically.
- Keep in a clean protection jacket.

Maintenance of Cabinet

For safety reasons, be sure to disconnect the AC power cord from the AC outlet.

- Do not use benzene, thinner, or other solvents for cleaning.
- Wipe the cabinet with a soft cloth.

A NOTE ABOUT RECYCLING



This product's packaging materials are recyclable and can be reused. This product and the accessories packed together are the applicable product to the WEEE directive except batteries.

Please dispose of any materials in accordance with your local recycling regulations.

When discarding the unit, comply with your local rules or regulations.

Batteries should never be thrown away or incinerated but disposed of in accordance with your local regulations concerning chemical wastes.

Table Of Contents

1 Before You Start	
Features.....	6
What's in the box.....	7
Putting the batteries in the remote control.....	7
Using the remote control.....	7
Discs compatible with this player.....	8
DVD-Video regions.....	9
General information.....	9
MP3 compatibility information.....	9
WMA compatibility information.....	9
JPEG compatibility information.....	9
DivX compatibility information.....	9
2 Connecting Up	
Easy setup.....	10
Home theater video connections.....	11
Home theater audio connections.....	12
3 Controls & Displays	
Front panel.....	13
Remote control.....	14
4 Getting Started	
Playing discs.....	15
Basic playback controls.....	15
Resuming playback from the last stopped point.....	15
Navigating DVD disc menus.....	16
Navigating Video CD PBC menus.....	16
5 Playing Discs	
Introduction.....	17
Preview function.....	17
Fast Forward/Fast Reversed.....	19
Still Frame/Slow Play/Frame Advance Playback.....	20
Using the page.....	21
Using the Repeat Play.....	21
Looping a section of a disc.....	22
Using the Random (SHUFFLE) Play.....	22
Switching Camera Angles.....	23
Switching the Subtitle Language.....	23
Switching the Audio Language.....	24
Switching the audio channel.....	24
Switching Super Audio CD Playback layer.....	24
Switching Super Audio CD Playback area.....	24
Using the Zoom Function.....	24
Play back Information.....	25
Playing an MP3/DivX/JPEG/Windows Media™	
Audio disc.....	28
Playing a JPEG image file (slide show).....	29
Playing MP3/WMA music and JPEG pictures	
simultaneously.....	30
Playing a DivX disc.....	31
Using the Setup Menu.....	32
6 DVD Setup Menu	
Setting up the GENERAL SETUP page.....	34
Setting up the AUDIO SETUP page.....	37
Setting up the VIDEO SETUP page.....	42
Setting up the PREFERENCE page.....	47
7 Additional Information	
Language Codes.....	51
Handling discs.....	52
Storing discs.....	52
Discs to avoid.....	52
Cleaning the pickup lens.....	52
Problems with condensation.....	52
Hints on installation.....	53
Moving the player.....	53
Precautions on using the power cord.....	53
Troubleshooting.....	54
Specifications.....	57

Features

An HDCP-compatible HDMI*¹ terminal is provided for fully digital transmission that ensures the very highest picture and digital sound quality.

This unit comes with a High-Definition Multimedia Interface (HDMI) jack; an extended DVI interface for next-generation televisions. This interface allows transfers of uncompressed digital video and digital audio (audio streams such as Dolby Digital and DTS as well as linear PCM) with a single connector. HDMI standard Ver. 1.1 compatibility means the unit can also transfer DVD-Audio multi-channel audio over HDMI.

End-to-end full-digital transfers with all digital processing allow the enjoyment of realistic video without any image degradation caused by AD/DA conversions. And the unit can up-convert 480p video signals to 720p, 1080i, and 1080p video output signals using the scaling function and the HDMI jack (see pages 11, 45).

High quality 12-bit/216 MHz Video D/A converter*²

The unit uses a Video D/A converter that performs D/A conversion of all video signals in 12-bits and can perform 8x oversampling to let you enjoy beautiful video possible with DVD. Furthermore, NSV technology suppresses noise during DA conversion.



DCDi (Directional Correction Deinterlacing) computes and tracks the angle of the screen edge to fill in the missing pixels on the TV screen. DCDi significantly optimizes the image quality, especially during slow motion playback. This function is available only for progressive scan output.

High quality 24-bit/192 kHz DAC

The high specification 24-bit/192 kHz DAC delivers dynamic, smooth and expansive analog sound from CDs and DVDs.

Superlative audio performance with Super Audio CD, DVD-Audio, Dolby*⁴ Digital and DTS*⁵ software

Logos:     

The DV6001 delivers breathtaking sound quality with Super Audio CD, DVD-Audio, Dolby Digital and DTS discs.

DivX *⁶

You can enjoy DivX® files which are recorded on DVD±R/RW or CD-R/RW. Plays DivX5.2, DivX4, DivX3 and DivX VOD Video content (see pages 28, 31).

- This player supports Quarter Pixel.
- This player supports GMC.

MP3 and WMA*⁷ compatibility

This player is compatible with CD-R, CD-RW and CD-ROM discs that contain MP3 and WMA audio tracks (see pages 28, 30).

JPEG compatibility

This player is compatible with CD-R, CD-RW and CD-ROM discs that contain JPEG data (see pages 28, 29, 30).

*¹ HDMI, the HDMI logo and High-Definition Multimedia Interface are trademarks or registered trademarks of HDMI Licensing LLC.

*² "NSV" is a registered trademark of Analog Device Co. Ltd.

*³ "DCDi" is a registered trademark of Faroudja, a division of Genesis Microchip, Inc.

*⁴ Manufactured under license from Dolby Laboratories. "Dolby" "Pro Logic" and the double-D symbol are trademarks of Dolby Laboratories.

*⁵ "DTS" and "DTS Digital Surround" are registered trademarks of DTS, Inc.

*⁶ "DivX", and "DivX Ultra" Certified, and associated logos are trademarks of DivX, Inc. and are used under license.

*⁷ Windows Media and the Windows logo are trademarks, or registered trademarks of Microsoft Corporation in the United States and/or other countries.

What's in the box

Thank you for buying this MARANTZ product. Please confirm that the following accessories are in the box when you open it.

- Remote control
- AAA/R03 dry cell batteries x2
- Audio/Video cable (yellow/red/white)
- System control cable
- Power cable
- User Guide (this manual)
- Warranty card

Putting the batteries in the remote control

- 1 **Open the battery compartment cover on the back of the remote control.**
- 2 **Insert two AAA/R03 batteries into the battery compartment following the indications (+, -) inside the compartment.**
- 3 **Close the cover.**

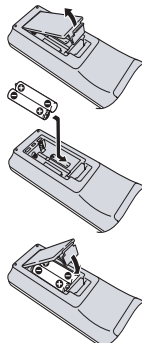

Note

Incorrect use of batteries can result in hazards such as leakage and bursting. Please observe the following:

- Don't mix new and old batteries together.
- Don't use different kinds of battery together. Although they may look similar, different batteries may have different voltages.
- Make sure that the plus and minus ends of each battery match the indications in the battery compartment.
- Remove batteries from equipment that isn't going to be used for a month or more.

When disposing of used batteries, please comply with governmental regulations or environmental bylaws that apply in your country or area.

Using the remote control

Keep in mind the following when using the remote control:

- Make sure that there are no obstacles between the remote control and the remote sensor on the unit.
- Use within the operating range and angle, as shown.

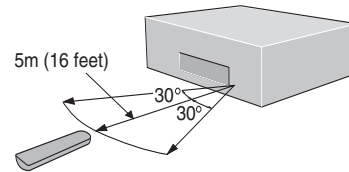

- Remote operation may become unreliable if strong sunlight or fluorescent light is shining on the unit's remote sensor.
- Remote controllers for different devices can interfere with each other. Avoid using remotes for other equipment located close to this unit.
- Replace the batteries when you notice a fall off in the operating range of the remote control.

Note

- When using this player independently, set the **REMOTE CONTROL** switch on the rear panel to **INT. (INTERNAL)** (see page 10).

Discs compatible with this player

Any disc that displays one of the following logos should play in this player. Other formats, including DVD-RAM, DVD-ROM, CD-ROM (except those that contain MP3/DivX/WMA/JPEG files) and Photo CD will not play.

DVD-Video compatibility:

- Logos: 
- Single-sided or double-sided discs
- Single layer or dual layer discs
- Dolby Digital, DTS, MPEG or Linear PCM digital audio
- MPEG-2 digital video

Discs are generally divided into one or more titles. Titles may be further subdivided into chapters.

DVD-Audio compatibility:

- Logos: 
- Single sided discs
- Single layer or dual layer discs
- Linear or packed PCM digital audio
- Some discs may contain MPEG-2 video, and Dolby Digital, DTS or MPEG digital audio

Discs are generally divided into one or more groups. Groups may be further subdivided into tracks.

DVD-R compatibility:

This unit can play DVD-R discs. Please note the following points when using these discs:

- Logo: 
- This unit can play DVD-R discs recorded as DVD-Video format.

DVD-RW compatibility:

This unit can play DVD-RW discs. Please note the following points when using these discs:

- Logo: 
- This unit can play DVD-RW discs recorded as DVD-Video format, and DVD-VR format.
- DVD-RW discs that were recorded with copy-once only permission can be played.

DVD+R/+RW compatibility:

- Logo: 
- This unit can play DVD+R/+RW discs. Please note the following points when using these discs.

Super Audio CD compatibility:

- Logo: 
- Single layer, dual layer or Hybrid layer
- 12cm (5in.) or 8cm (3in.) discs
- Digital audio (DSD)

Super Audio CDs are divided into tracks.

Audio CD compatibility:

- Logos: 
- 12cm (5in.) or 8cm (3in.) discs
- Linear PCM digital audio
- Audio CD, CD-R* and CD-RW* formats

CDs are divided into tracks.

*This unit can play CD-R and CD-RW discs recorded in Audio CD or Video CD format, or with MP3 audio files or Windows Media audio files or picture files or DivX files.

*Some copy-controlled CDs may not conform to official CD standards. They are special discs and may not play on the DV6001.

*The DV6001 does not support the non-DVD side of a Dual Disc.

Video CD compatibility:

- Logo: 
- 12cm (5in.) or 8cm (3in.) discs
- MPEG-1 digital audio
- MPEG-1 digital video

Video CDs are divided into tracks.

Super VCD compatibility:

- Logo: 
- 12cm (5in.) or 8cm (3in.) discs
- MPEG-1 digital audio
- MPEG-2 digital video

Super VCDs are divided into tracks.

DVD-Video regions

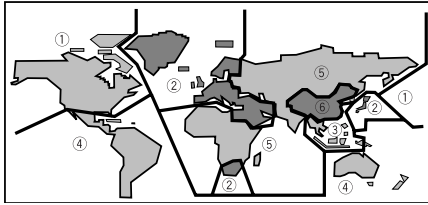

All DVD-Video discs carry a region mark on the case somewhere that indicates which region(s) of the world the disc is compatible with. Your DVD player also has a region mark, which you can find on the rear panel. Discs from incompatible regions will not play in this player. Discs marked **ALL** will play in any player.

General information

- This player can recognize in total about 650 files per folders and 300 folder per disc for MP3/DivX/WMA.
- When writing MP3/WMA/JPEG/DivX files to CD-R/RW discs, always be sure to set the writing format to ISO 9660 Level 1.
- For MP3 and WMA files recorded in Variable Bit Rate (VBR), the unit may not display the actual elapsed time.

MP3 compatibility information

- Files should be MPEG1 Audio Layer 3 format. The sampling rate is 8 kHz to 48 kHz, but it is depends on the bit rate. Incompatible files will not play.
- Audio encoded at 128 kbps should sound close to regular audio CD quality. Although this player will play 32 kbps to 320 kbps, but it is depends on the sampling rate.
- This player is compatible with ID3 ver.1.1 Tag. But the information display on the display on the Front panel and TV screen is only ID3 ver. 1.0 Tag.
- Maximum 30 characters can be displayed on the display on the Front panel and TV screen.
- This player cannot play DVD-R/RW discs with recorded MP3 music data.
- This player only plays tracks that are named containing the file extension “.mp3” or “.MP3”.
- This player is not compatible with multi-session discs. If you try and play a multi-session disc, only the first session will be played.

WMA compatibility information

- The sampling rate is 44.1 kHz (bit rate: 64 kbps-192 kbps) and 48 kHz (bit rate: 128 kbps-192 kbps).
- This player only plays tracks that are named with the file extension “.wma” or “.WMA”.

- This player can not play the disc contents protected by Windows Media Digital Right Management (DRM).

JPEG compatibility information

- While this player is designed to be able to handle image data recorded in JPEG format, no assurances are given that the player will be able to display image data recorded in all JPEG formats.
- This player can not display progressive JPEG images.
- This player can not display HD JPEG images.
- Always be sure to specify a file extension of “.JPG” or “.JPEG” for JPEG files. The file will not be able to be displayed if a file extension other than “.JPG” or “.JPEG” is specified or if no file extension is assigned to the file. (Note that this means that JPEG files created on a Macintosh will not be able to be displayed as is.)
- Depending on the file size and compression ratio, some JPEG pictures cannot be displayed correctly.

DivX compatibility information

- A file with an extension of “.avi” or “.divx” is called a DivX file.
- Maximum 30 characters can be displayed on the display on the Front panel and TV screen.
- Maximum 4 Gbyte of file size can be displayed.
- File should be MPEG1 Audio Layer 3 format and MPEG2 format.

Caution!

- DVD±R/RW and CD-R/RW discs recorded using a personal computer or a DVD or CD recorder may not play if the disc is damaged or dirty, or if there is dirt or condensation on the player's lens.
- If you record a disc using a personal computer, even if it is recorded in a compatible format, there are cases in which it may not play because of the settings of the application software used to create the disc. (Check with the software publisher for more detailed information.)
- There may be times when it is impossible to replay a CD-R/RW disc because of the characteristics of the disc being used or because of dirt or scratches on the disc.
- Unfinalized DVD-R/RW discs cannot be played.
- Unfinalized CD-R/RW discs cannot be played.
- For more information on using DVD-R/RW and CD-R/RW discs, see “Handling discs” on **page 52**.
- Never try to replay anything other than a music CD (CDA format) or a CD-R/RW on which MP3 and/or JPEG files have been stored. Depending on the type of file, there may be times when doing so will result in problems or erroneous operation.

Easy setup

This easy setup is the minimum set of connections you need to start watching DVD-Video discs. Both sound and picture are fed directly to your TV using the supplied audio/video cables. For other possible connections, see pages 11 and 12.

Important

- Before making or changing any rear panel connections, make sure that all components are switched off and unplugged from the wall outlet.
- While a connected component is turned on, do not unplug the power cord of this DVD player from the wall outlet. The speaker may be damaged.

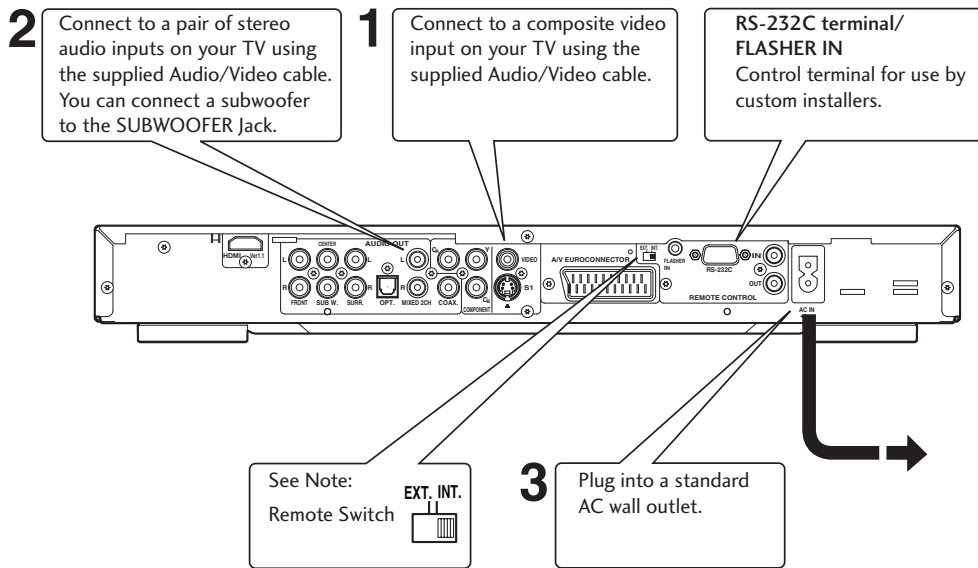

Connecting audio/video cables

Be sure to insert each plug fully for the best connection. The plugs and jacks are color-coded to make connection easier.

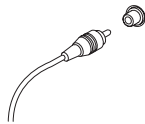

Connecting system control cables

By connecting this DVD player to another Marantz audio component using a supplied system control cable, you can remotely operate the components as a single system.

- When connecting to a component with a remote sensor, be sure to connect the **REMOTE CONTROL IN** jack of this DVD player to the **REMOTE CONTROL OUT** jack of the component with the remote sensor.
- When connecting to component which is not equipped with a remote sensor, be sure to connect the component to the **REMOTE CONTROL OUT** jack of this DVD player.

Note

- When connecting to a standard TV, select **4:3 LETTER BOX** or **4:3 PAN SCAN** in the TV Aspect setting (see page 43).
- Connect the video output of the player directly to your TV. Because the player is designed to support an Analog Protection System copy card, there are cases when proper playback will be not be possible if the player is connected to the TV through a VCR and images are recorded and played on the VCR.
- The player's video output and S1 output are not be progressive.
- **Remote switch**
When using this DVD player independently, set this switch to **INT. (INTERNAL)**. When using this DVD player in a system with a Marantz receiver equipped with a remote sensor, set the switch to **EXT. (EXTERNAL)**.
- **Flasher Input**
This is used when controlling components from different rooms with a keypad or other input device. Set the remote switch to **EXT. (EXTERNAL)** when using a flasher input.

Home theater video connections

This player outputs video in a number of different ways. Choose the one most suitable for your system using the guide below.

Important

- Before making or changing any rear panel connections, make sure that all components are switched off and unplugged from the wall outlet.
- While a connected component is turned on, do not unplug the power cord of this DVD player from the wall outlet. The speaker may be damaged.

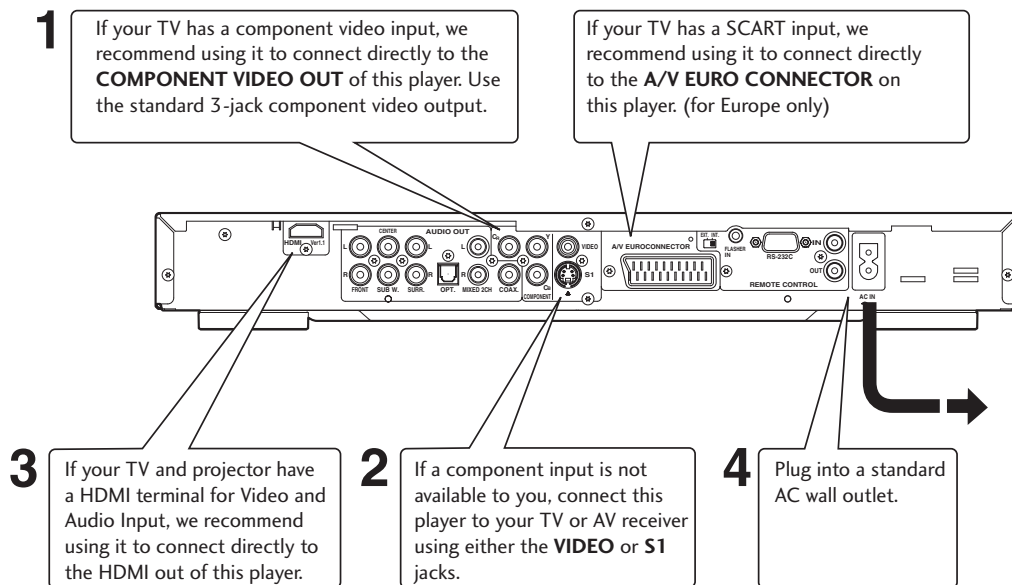

Connecting SCART (for Europe only) and S-Video cables

SCART and S-Video cables will only plug in one way, so make sure the plug is correctly lined up with the jack before inserting. Be sure to fully insert for a good connection.

Note

- The **A/V EURO CONNECTOR** can output composite or RGB component video. If you connect just one TV, use the **A/V EURO CONNECTOR**. You can select the type of video output by changing the **COMPONENT** setting in the **DVD Setup Menu** (page 46).

S-Video or composite video?

S-Video should give a better picture, so if you have an S-Video input, use it. S-Video cables are available from any good audio/visual dealer.

Connecting HDMI cables

With an HDMI cable, both uncompressed video data and digital audio data (e.g., LPCM or bit stream data such as Dolby Digital, DTS, MPEG data or DVD Audio Multi channel) can be transmitted with just a single connector.

By transmitting DVD image data directly as digital data without it being first converted into analog format, it becomes possible to provide the very finest in image quality (see pages 6, 39, 40, 45).

Note

- The HDMI output of this unit can be connected to a DVI jack on a TV or other device using a conversion adapter. In this case, it is necessary to use a TV or display with an HDCP-compatible DVI input.
- There may be no image output if connected to a TV or display that is not compatible with the above format.
- Refer to the instruction manual of the TV or display to be connected to this unit for detailed information regarding the HDMI terminal.
- When connecting a progressive input TV with the component output of the player, select **ON** in the Progressive setting (see page 43).

Home theater audio connections

This player outputs multi-channel audio in digital form. Check the manual for your amplifier/receiver to see what equipment it is compatible with (especially which digital formats such as Dolby Digital, DTS, etc. It can decode).

Important

- Before making or changing any rear panel connections, make sure that all components are switched off and unplugged from the wall outlet.
- While a connected component is turned on, do not unplug the power cord of this DVD player from the wall outlet. The speaker may be damaged.

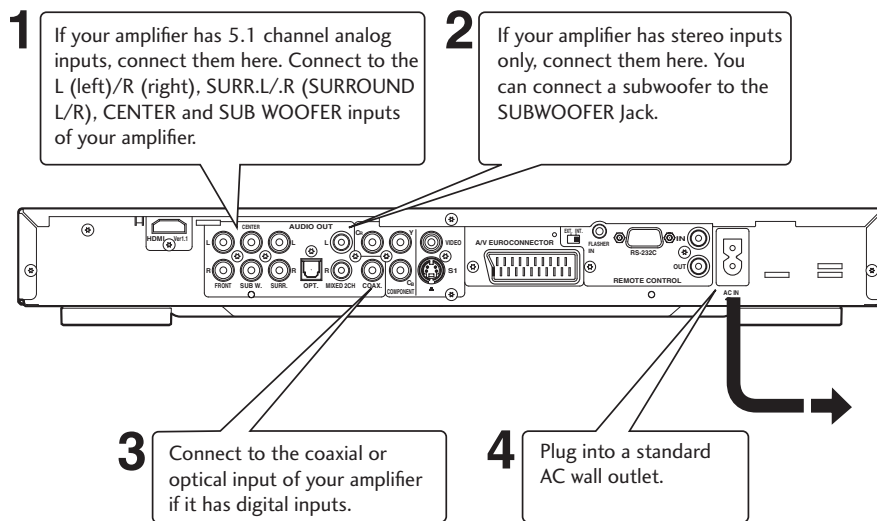

Connecting analog audio cables

Be sure to fully insert each plug for the best connection. The plugs and jacks are color-coded to make connection easier.

Connecting coaxial cables

Use an interconnector with a pin-type (also called RCA or phono) plug on each end to connect up digital coaxial-type jacks. Make sure that the plug is pushed fully home.

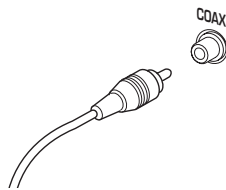

Connecting optical cables

Optical interconnects only plug in one way, so make sure the plug is correctly lined up with the jack before insertion. When inserting the plug,

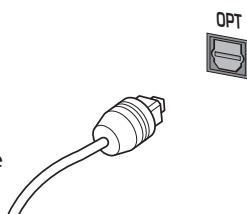

the protective shutter will open and you should hear it click into position when fully inserted. Be careful that you do not force the plug, because this could result in damage to the protective shutter, the cable, or the unit itself.

Note

- If you listen to multichannel DVD-Audio through one of the digital outputs, it will be downmixed to stereo. Also, high sampling rate DVD-Audio (192 kHz or 176.4 kHz) will be downsampled to 96 kHz, 88.2 kHz, 48 kHz or 44.1 kHz, depending on the disc. Multi channel and high sampling rate DVD-Audio are only available through the analog outputs.
- All DVD-Audio and all Super Audio CD audio are output only through the analog outputs. (see page 38)

Front panel

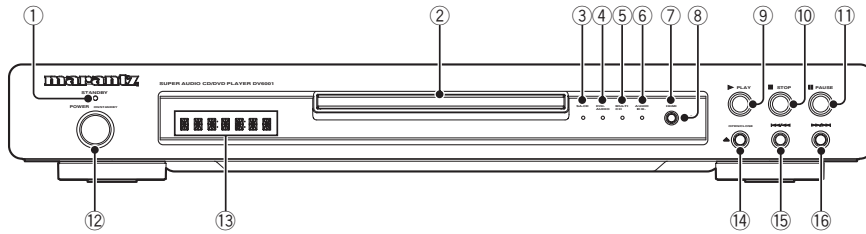

- 1 STANDBY indicator**
 - Lights when the unit is in standby.
- 2 Disc tray**
 - Place the disc here.
- 3 SA-CD indicator**
 - Lights when the player detects a Super Audio CD signal.
- 4 DVD-AUDIO indicator**
 - Lights when the player detects a DVD-AUDIO signal.
- 5 MULTI-CH indicator**
 - Lights when playing a multi-channel audio source.
- 6 AUDIO EX**
 - Lights when the AUDIO EX is activated using the AUDIO EX button on the remote control.
 - The sound quality of analog audio output is improved by turning off analog video signal output and the front panel display.
 - It is applied to CDDA, Super Audio CD, DVD Audio and DTS CD in Play mode.
- 7 HDMI – page 45**
 - The HDMI on/off state toggles when pressed for three seconds or more. When on, the HDMI indicator is lit.
 - Pressing this button while HDMI is enabled displays the current resolution. Pressing this button again while the resolution is displayed allows you to select the resolution in the sequence below:
480p → 576p → 720p → 1080i → 1080p → 480p
- 8 HDMI indicator**
 - When the connected device is HDMI/DVI compatible, the light flashes red.
- 9 ► (PLAY)**
 - Begins playing the disc play.
- 10 ■ (STOP)**
 - Stops playing the disc play.
- 11 || (PAUSE)**
 - Pauses playing the disc play.
- 12 POWER ON/STANDBY**
 - Press to turn the power on, and press it again to enter STANDBY mode.
- 13 Display**
 - Operation indications are displayed here.
- 14 ▲ (OPEN/CLOSE)**
 - Press to open and close the disc tray.
- 15 ◀◀ / ▶▶**
 - Press to skip reverse title/group, chapter, or track. You can also press and hold this button for Fast Reversed.
- 16 ▶▶ / ▶▶▶**
 - Press to skip forward title/group, chapter, or track. You can also press and hold this button for Fast Forward.

Remote control

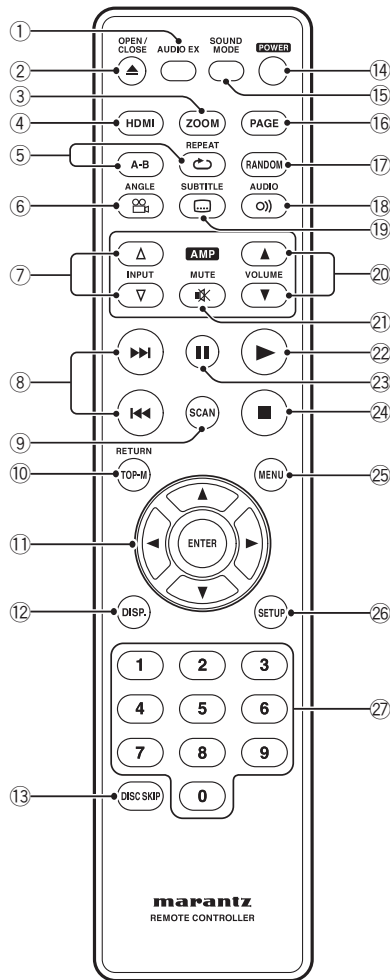

- 1 **AUDIO EX** – Press to turn **AUDIO EX** off and on
 - The sound quality of analog audio output is improved by turning off analog video signal output and the front panel display.
 - HDMI video output cannot be switched off.
- 2 **OPEN/CLOSE** – Disc tray open/close – page 15
- 3 **ZOOM** – pages 24, 29
- 4 **HDMI** – page 45
 - The HDMI on/off state toggles when pressed for three seconds or more. When on, the HDMI indicator is lit.
 - Pressing this button while HDMI is enabled displays the current resolution. Pressing this button again while the resolution is displayed allows you to select the resolution in the sequence below:

480p → 576p → 720p → 1080i → 1080p → 480p

- 5 **REPEAT** – pages 21, 28
A-B – page 22
- 6 **ANGLE** – pages 23, 29
- 7 **INPUT (Δ/∇) button** – These buttons can switch between devices compatible with MARANTZ receivers. Refer to the receiver instruction manual for further details.
 - Applicable models: PM-11S1, PM-15S1, PM6001, PM7001, PM8001, SR9600. (These models may not be handled depending on the area.)
 - Non-applicable models: MARANTZ Amplifiers and receivers which had released before 2006, including PM-14, PM-17 and PM4001 except above models.
- 8 **◀◀ (PREV.)/▶▶ (NEXT)** – Skip – pages 15, 16, 18, 19, 28, 29, 49
 - Allows you to search forward/backward through a disc. Use to skip the title, chapter or track.
 - Press and hold (◀◀) for Fast Reversed.
 - Press and hold (▶▶) for Fast Forward.
- 9 **SCAN** – pages 17, 18
- 10 **TOP MENU (TOP-M)/RETURN** – page 16
- 11 **Cursor (◀/▶/▲/▼) / ENTER button**
- 12 **DISPLAY (DISP.)** – page 25
- 13 **DISC SKIP** – It is not used on this set.
- 14 **POWER** – Switches the player on or into standby – page 15
- 15 **SOUND MODE** – Selects Audio out mode and change the Super Audio CD Play back area – pages 24, 37
- 16 **PAGE** – Turns the pages of DVD-Audio still pictures – page 21
- 17 **RANDOM** – page 22
- 18 **AUDIO** – Changes the Hybrid Super Audio CD Play back layer – page 24
- 19 **SUBTITLE** – pages 23, 31
- 20 **VOLUME (▲/▼) button** – These buttons can adjust the volume of devices compatible with MARANTZ receivers. Refer to the receiver instruction manual for further details.
- 21 **MUTE button** – This button can activate the mute function of devices compatible with MARANTZ receivers. Refer to the receiver instructions for further details.
- 22 **▶ (PLAY)** – pages 15, 19, 20, 28, 30, 31
- 23 **⏸ (PAUSE)** – pages 15, 20
- 24 **■ (STOP)** – pages 15, 29, 30, 32, 47
- 25 **MENU** – pages 16, 18, 23
- 26 **SETUP** – pages 32, 34, 37, 42, 47
- 27 **Number buttons**

 **Note**

- **HDMI ON** is set when the unit is shipped from the factory.
- Set **HDMI** under the **DVD Setup Menu** to use HDMI functions (see pages 39, 40, 45).

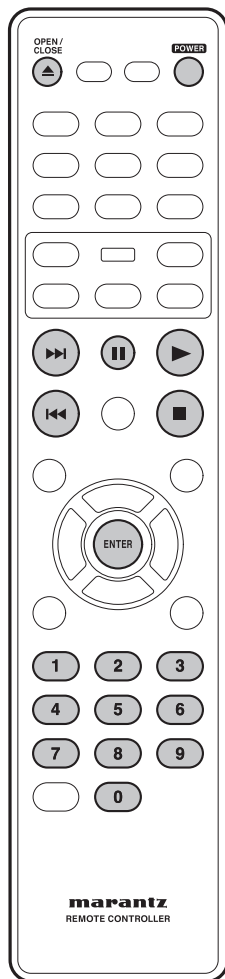

Playing discs

The basic playback controls for playing discs are covered here. Further functions are detailed in the next chapter.

Note

- Throughout this manual, the term “DVD” means DVD-Video, and DVD±R/RW. If a function is specific to a particular kind of DVD disc, it is specified.

- 1 Press the **POWER ON/STANDBY** button on the front panel or **POWER** button on the remote control.
If you are playing a DVD or Video CD, also turn on your TV and make sure that it is set to the correct video input.
- 2 Press **OPEN/CLOSE** to open the disc tray.

3 Load a disc.

Load a disc with the label side facing up, using the disc tray guide to align the disc (if you're loading a double-sided DVD disc, load it with the side you want to play face down).

4 Press ► (PLAY) to start playback.

If you are playing a DVD or Video CD, a menu may appear (see [page 16](#)).

Note

- For one-sided, two-layer discs containing movies, etc., there may be a short image stoppage at the point where the layers change. This is not a malfunction.
- Depending on the DVD or VIDEO CD, some operations may be different or restricted.

Basic playback controls

Button	What it does
►	Starts playback. In title menu, it functions as the Enter key.
	Pauses a disc that's playing. Each time the button is pressed, a new frame will appear.
■	Stops playback.
◀◀	<ul style="list-style-type: none"> Skips to the start of the current track or chapter, then to previous tracks/chapters. Press and hold for Fast Reversed.
▶▶	<ul style="list-style-type: none"> Skips to the next track or chapter. Press and hold for Fast Forward.
Numbers	Playback starts from the selected track/chapter number.
ENTER	Select the current menu option.

Resuming playback from the last stopped point

This DVD system is able to resume disc playback from its last stopped point (only possible for the last 10 discs that were recorded without a menu).

- 1 Load one of the last 10 discs played.
- 2 While “LOADING” appears on the display panel, press **PLAY ►** to start playback from the last stop point.

To cancel the resume mode

- Press ■ twice.

Important

While using the DVD playback controls, you may see the mark displayed on-screen. The mark means that the operation is not allowed by the player and disc.

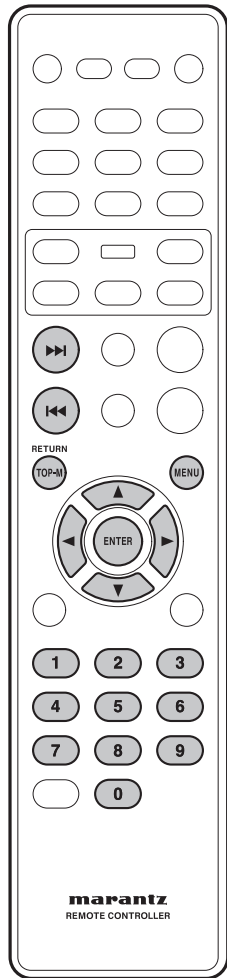

Navigating DVD disc menus

Many DVD discs contain menus. Sometimes these are displayed automatically when you start playback; others only appear when you press **MENU** or **TOP-M**.

Note

- Some DVD-Audio discs feature a “Bonus Group”. To access this group you have to input a password that you can find on the disc’s packaging (see [page 34](#)).

Button	What it does
TOP-M	Displays the “top menu” of a DVD disc. This varies with the disc.
MENU	Displays a DVD disc menu—this varies with the disc and may be the same as the “top menu”.
RETURN	Returns to the previously displayed menu screen.
Cursor (←/→/▲/▼)	Moves the cursor around the screen.
ENTER	Selects the current menu option.
Numbers	Selects a numbered menu option (some discs only).

Navigating Video CD PBC menus

Some Video CDs have menus from which you can choose what you want to watch. These are called **PBC (Playback control)** menus.

Press the **MENU** to turn the PBC function on or off.

Note

- Some discs don’t allow PBC menus.

Button	What it does
RETURN	Displays the PBC menu.
Numbers	Selects a numbered menu option.
ENTER	Selects the current menu option.
◀◀	Displays the previous menu page (if there is one).
▶▶	Displays the next menu page (if there is one).

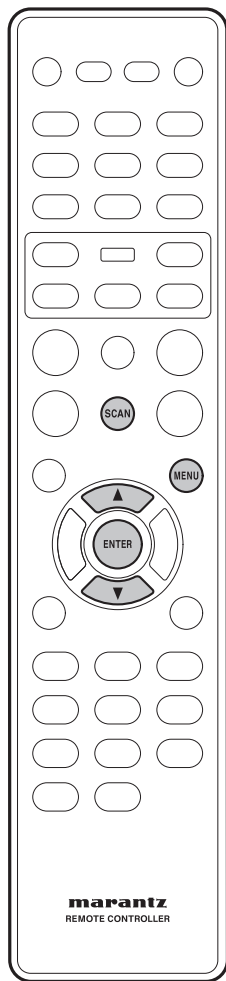

Preview function

Video-CD SVCD DVD-Video CD

1 Press SCAN.

SVCD VCD

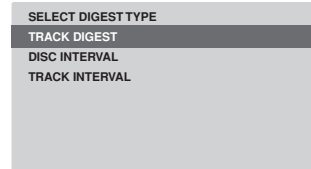

DVD

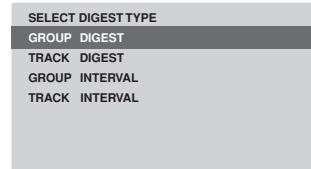
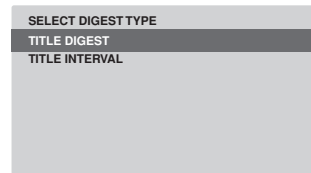

2 Use the ▲/▼ keys to select one of the following options and press ENTER.

This option is only available during playback mode.

- **TRACK/TITLE/CHAPTER DIGEST** – View six different TRACK/TITLE/CHAPTER on one screen each time. This allows you to have a quick glance at all the TRACK/TITLE/CHAPTER on the disc.
- **DISC INTERVAL** – View the whole disc in six thumbnail pictures. It divides a disc into six portions at regular intervals and displays them on one screen.
- **TRACK INTERVAL** – View the content of a single track in six thumbnail pictures. It divides a single track into six portions at regular intervals and displays them on one screen.
- **TITLE INTERVAL/CHAPTER INTERVAL** – View the content of a single TITLE/single CHAPTER in six thumbnail pictures. It divides a single TITLE/CHAPTER into six portions at regular intervals and displays them on one screen.
- **GROUP/TRACK DIGEST** – GROUP/TRACK DIGEST will playback the first 3 to 4 seconds of every title/chapter available in the disc/current title.

Introduction

- Many of the functions covered in this chapter apply to DVD discs, Video CDs and CDs, although the exact operation of some varies slightly with the kind of disc loaded.
- When playing DVD discs, if the  icon appears on-screen when you try to use a particular function, either the player or the disc doesn't allow the use of that function.
- When playing Video CDs, some of the functions are not available in PBC mode. If you want to use them, press the MENU to turn the PBC function off (see page 16).

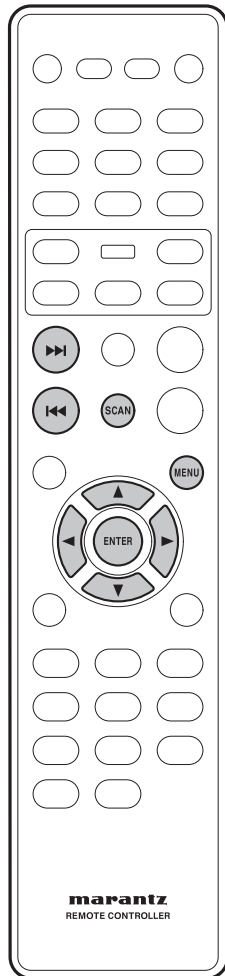

- **GROUP/TRACK INTERVAL** – GROUP/TRACK INTERVAL will divide the current title disc/chapter time by 6 and playback the first 3 to 4 seconds of each of these intervals.



- Use (◀/▶/▲/▼) to select a track or use the numeric buttons to enter the selected track number.
 - To go to the previous or next page, press ◀◀/▶▶.
 - Press **ENTER** on the selected thumbnail picture to start playback from there.
 - To return to the main menu, select **MENU** on the screen and press **ENTER**.
- 3 To exit the preview menu, select EXIT on the screen and press ENTER.**

For CD

- At stop mode, press **SCAN** on the remote control. Each track will be played for a few seconds.

Note

- You can select "Track Interval" only during playback with PBC off.
- Some discs don't allow the Scan mode.

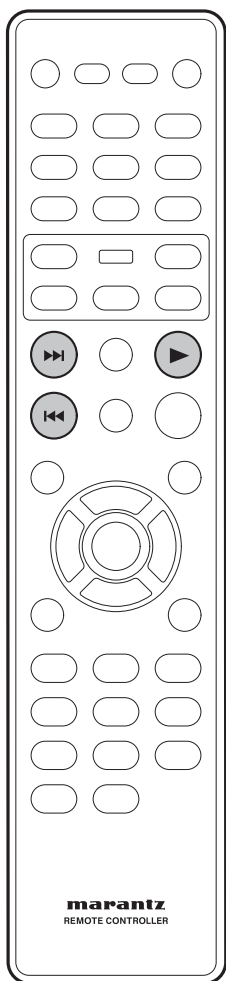

Fast Forward/Fast Reverse

DVD Super Audio CD Video-CD CD
MP3 DivX WMA

The video images on DVD and VCD can be viewed as a Fast Forward and Fast Reverse with no sound.

In case of CD, the sound can be listened as a Fast Forward and Fast Reverse with sound.

Viewing in Fast Forward/Fast Reversed

Press and hold **▶▶▶ (NEXT)** during play.

- Fast Forward is engaged.
- During Fast Forward, the speed of play back can be adjusted from x2 speed to x32 speed in 5 steps using **▶▶▶ (NEXT)**.

Press and hold **◀◀◀ (PREV)** during play.

- Fast Reverse is engaged.
- During Fast Reverse, the speed of play back can be adjusted from x2 speed to x32 speed in 5 steps using **◀◀◀ (PREV)**.

To return to normal play back press **▶ (PLAY)** to normal play back.

Note

- The sound is muted during fast forward/reverse scanning of DVD/VCD/Super Audio CD.

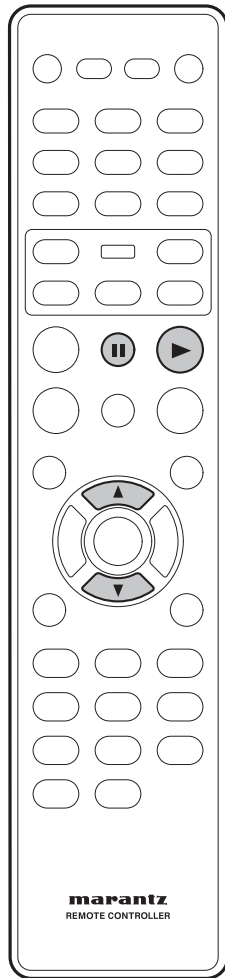

Still Frame/Slow Play/Frame Advance Playback

(DVD-Video) (Video-CD)

The video images on DVD and Video CD can be viewed as a still frame, played back at slow speeds and even advanced frame by frame (Forward only).

Viewing a Paused Picture

Press **II (PAUSE)**.

Viewing slow playback

With this function, DVDs can be viewed in both forward and reverse direction. Video CD can only be moved in the forward direction.

Press **▼ (down)** during play.

- Slow playback is engaged.
- During slow playback, the speed of playback can be adjusted from 1/2 normal playback speed to 1/16 normal playback speed in 4 steps using **▼ (down)**. $1/2 - 1/4 - 1/8 - 1/16$

Press **▲ (up)** during play.

- Slow playback in the reverse direction is engaged.
- During slow playback, the speed of playback can be adjusted from 1/2 normal playback speed to 1/16 normal playback speed in 4 steps using **▲ (up)**. $1/2 - 1/4 - 1/8 - 1/16$

To return to normal playback

When the picture is paused or during slow playback, pressing **▶ (PLAY)** restores normal playback operation.

Step Motion playback: Viewing one frame at a time

With this function, DVDs and Video CDs can only be moved in the forward direction.

Press **II (PAUSE)**.

Each time the button is pressed, a new frame will appear.

To return to normal playback

When viewing Step Motion playback, pressing **▶ (PLAY)** restores normal playback operation.

Note

- There is no sound picture playback is paused or during slow playback, or when advancing one frame at a time.
- Pausing picture, slow play, or Step Motion playback may not be possible with certain titles. In this case, the mark is displayed.
- A short sound may be noticeable when switching to slow playback.
- When you press the **II (PAUSE)** button during slow playback, it may advance a few frames past the frame where you want it to stop.

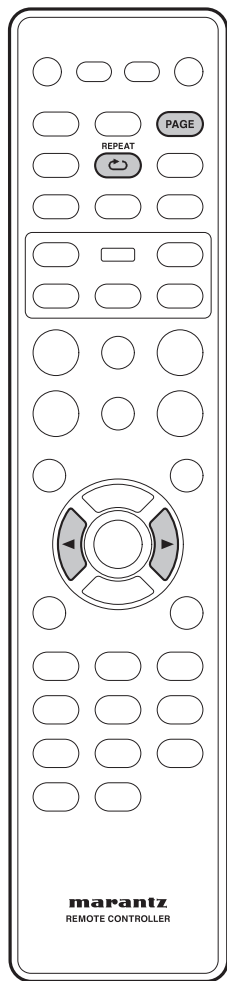

Using the page

DVD-Audio

Some DVD-Audio discs contain information pages for photo galleries, artist biographies, lyrics, etc. Press the **PAGE** button on the remote control during Playback. You may select the image you want by moving the cursor button (◀/▶).

Using the Repeat Play

DVD-Video **DVD-Audio** **Super Audio CD** **Video-CD**

CD **MP3** **JPEG** **DivX** **WMA**

You can set the player to repeat individual tracks on CDs or Video CDs, chapters or titles on DVD discs, or the whole disc. It's also possible to loop a section of a disc.

You can't use any repeat mode or looped play with a Video CD playing in PBC mode.

Note

- Some discs don't allow the Repeat function.

Press REPEAT during playback to select a repeat mode.

Each press switches the repeat mode:

DVD-Video

- CHAPTER REPEAT
- TITLE REPEAT
- DISC REPEAT
- OFF

DVD-Audio

- TRACK REPEAT
- GROUP REPEAT
- DISC REPEAT
- OFF

Video-CD **CD** **MP3** **WMA** **Super Audio CD**

JPEG **DivX**

- TRACK REPEAT
- DISC REPEAT
- OFF

Note

Any existing RANDOM or Repeat A-B mode will be cancelled and Repeat mode will be activated.

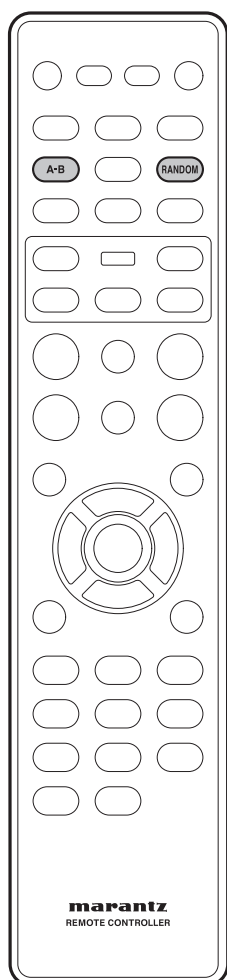

Looping a section of a disc

DVD Super Audio CD Video-CD CD
MP3 DivX WMA

- 1 Press A-B once at the start of the section you want to repeat, then again at the end.

Playback immediately jumps back to the start point and plays the loop round and round.

- On a DVD disc, the start and end points of the loop must be in the same title/chapter.
- On a Video CD/CD disc, the start and end points of the loop must be in the same track.

- 2 To resume normal playback, press A-B again.



Note

- There may be a slightly difference between point A and the location where playback actually resumes depending on the disc.
- After Repeat A-B is exited, any existing Repeat or RANDOM modes will be restored.

Using the Random (SHUFFLE) Play

CD MP3 DivX WMA JPEG

Use the random play function to play tracks in a random order.

You can't use random play with DVD-VR mode.

Press the RANDOM button during playback to select a RANDOM (SHUFFLE) mode.

- SHUFFLE
- SHUFFLE REPEAT
- SHUFFLE OFF

To cancel Random mode, press RANDOM.



Note

- Any existing Repeat or Repeat A-B modes will be cancelled and RANDOM mode will be activated.
- If the disc currently playing is a CD layer of Super Audio CD, CD layer of Super Audio CD will be played.
- For Hybrid Super Audio CDs, tracks on the Super Audio CD layer are played by default.

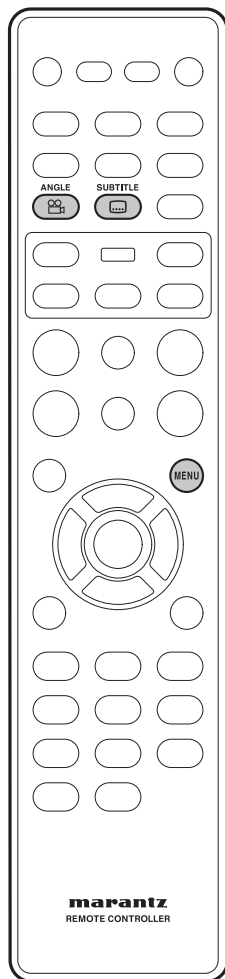

Switching Camera Angles

(DVD-Video)

Some DVD-Video discs feature scenes shot from two or more angles. Check the disc box for details: it should be marked with a  icon if it contains camera-angle scenes.

- To switch the camera angle, press **ANGLE**.

Note

- Depending on the disc, this feature may not work.

Switching the Subtitle Language

(DVD-Video) (DivX)

Many DVD-Video discs or DivX discs have subtitles in one or more languages. The disc box will usually tell you which subtitle languages are available. You can switch the subtitle language at anytime during playback.

- To display/switch the subtitle language, press **SUBTITLE** repeatedly.

The current subtitle language is shown on-screen.

- To set subtitle preferences, see page 47.

Note

- In some cases, a subtitle can not be turned off even if you select "OFF".
- Some discs allow you to change subtitles only via the disc menu. In that case, press the **MENU** button and change the settings.

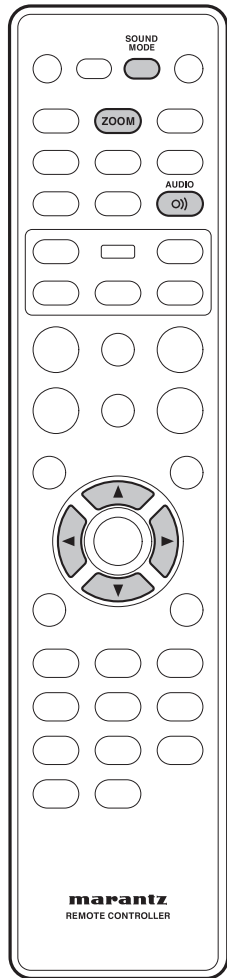

Switching the Audio Language

(DVD-Video) (DVD-Audio)

When playing a DVD-Video disc recorded with dialog in two or more languages, you can switch the audio language at anytime during playback.

- To display/switch the audio language, press **AUDIO** repeatedly.
The current audio language is shown on-screen.
- To set audio language preferences, see page 47.

Note

- Depending on the disc, there are cases in which the audio language cannot be switched during play. In this case, make changes using the DVD menu.
- It may take a few seconds till a selected Audio Language is audible.

Switching the audio channel

Depending on the disc, this feature may not work.

(Video-CD)

On Video CDs you can switch between stereo, just the left channel, just the right channel or Mixed Mono.

- To switch the audio channel, press **AUDIO** repeatedly.
The current playback channel(s) are indicated on-screen.

Switching Super Audio CD Playback layer

(Super Audio CD)

- On a hybrid disc (with Super Audio CD and CD layers), the player will always start playing the Super Audio CD layer.
- To switch between the Super Audio CD layer and the CD player, press **AUDIO** while playback is stopped.

Switching Super Audio CD Playback area

(Super Audio CD)

- To Switch between the Super Audio CD multi-channel and Super Audio CD stereo areas by pressing **SOUND MODE**.

Using the Zoom Function

(DVD-Video) (DVD-Audio) (Video-CD) (JPEG)

- 1 During play or pause mode, press the **ZOOM** button on the remote control to zoom in x2, x3, x4, x1/2, x1/3, x1/4, Normal in order for DVD-Video or VCD and 100%, 125%, 150%, 200%, Normal in order for JPEG.
- 2 Use the cursor buttons (**▲/▼/◀/▶**) to select the part of the screen you want to zoom in on.

Note

- Zoom play cannot be used on some discs.
- Zoom will not operate properly for some scenes.
- Zooming may cause image deterioration or shaking.

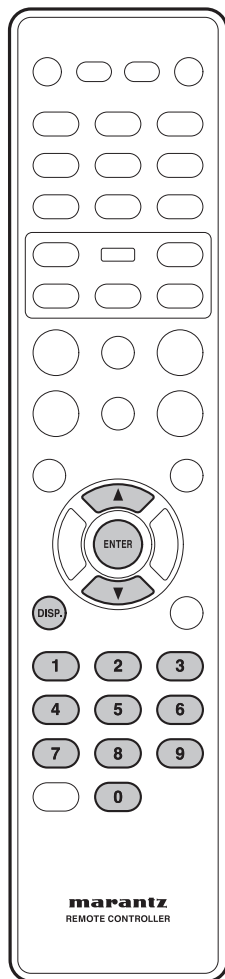

Play back Information

This DVD system can display the disc playback information (for example, title or chapter number, elapsed playing time, audio/subtitle language) and a number of operations can be done without interrupting disc playback.

DVD-Video **Video-CD**

1 During playback, press DISP.

- A list of available disc information appears on the TV.

DVD

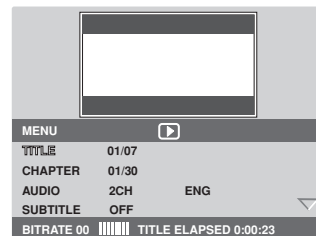

Video-CD **SVCD**

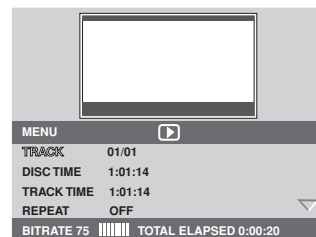

Title/Chapter/Track selection

DVD-Video **Video-CD**

- 1 Press ▲/▼ to highlight “Title” / “Chapter” or “Track”, then press ENTER to access.
- 2 Use the numeric keypad (0-9) to enter a valid number (e.g. 04/05).

Audio/Subtitle

DVD-Video

- 1 Press ▲/▼ to highlight “Audio” or “Subtitle”, then press ENTER to access.
The Audio or Subtitle menu appears on the TV.
- 2 Press ▲/▼ to select one language, then press ENTER to confirm.
The current audio or subtitle language will be changed to the selected language.

Angle**DVD-Video**

- 1 Press ▲/▼ to highlight “Angle”, then press ENTER to access.
- 2 Use the numeric keypad (0-9) to enter in a valid number.
- 3 Press ENTER to confirm.
Playback will go to the selected angle.

Time Display**DVD-Video** **Video-CD**

- 1 Press ▲/▼ to highlight “Time Disp.”, then press ENTER to access.
The following display types appear on the TV, depending on the disc in the player.

For DVD discs:

TITLE Elapsed - elapsed playing time of current Title;
 TITLE Remain - remaining playing time of current Title;
 CHAPTER Elapsed - elapsed playing time of current Chapter;
 CHAPTER Remain - remaining playing time of current Chapter;

For VCD/SVCD discs:

Total Elapsed - elapsed playing time of current Disc;
 Total Remain - remaining playing time of current Disc;
 Single Elapsed - elapsed playing time of current Track;
 Single Remain - remaining playing time of current Track;

- 2 Press ▲/▼ to select the desired time display mode, then press ENTER to display the selected item.

Time Search**DVD-Video** **Video-CD**

- 1 Press ▲/▼ to highlight “TT Time”/“CH Time”/“Disc Time” or “Track Time”, then press ENTER to access.
- 2 Use the numeric keypad (0-9) to enter a valid time (e.g. 0:34:27).
The playback skips to the chosen time.

Repeat**DVD-Video** **Video-CD**

- 1 Press ▲/▼ to highlight “REPEAT”, then press ENTER to access.
- 2 Press ▲/▼ to select the desired repeat mode, then, press ENTER to access.

Group/Track Selection and time search

DVD-Audio

Each time you press **DISPLAY**, the TV display changes as follows, and the time display changes as follows:

Display Example:

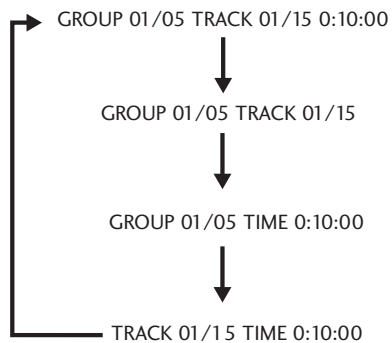

- 1 **Displays the current group number/total number, the current track number/total number and elapsed playing time.**
- 2 **To select a track/group:**
 - 1 Use **◀/▶** to highlight GROUP or TRACK.
 - 2 Enter a group/track number using the **numeric keypad (0-9)**.
 - 3 Press **ENTER** to confirm the selection, or wait for about 5 seconds without performing any operation.
- 3 **To search for a time in a group:**
Enter hours, minutes and seconds from left to right using the numeric keypad (0-9).
- 4 **To search for a time in a track:**
Enter hours, minutes and seconds from left to right using the numeric keypad (0-9).

Note

- When searching for a time in a group/ track, if you enter a time outside the total time for the group/track currently being played back, **⊘ INPUT INVALID** is displayed.

Time

CD

Press **DISPLAY (DISP.)** repeatedly during playback to change the displayed disc time information.

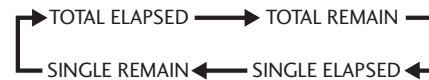

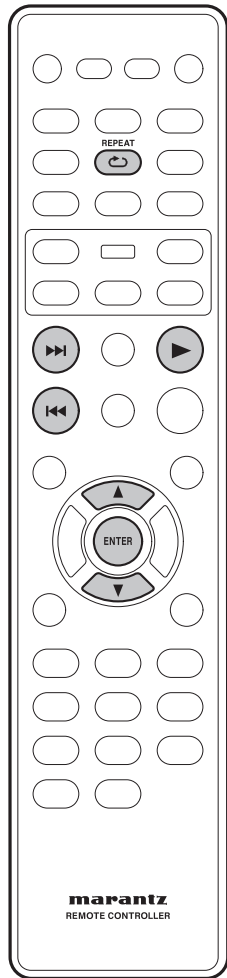

1 Insert a disc.

- The disc reading time may exceed 30 seconds due to the complexity of the directory file configuration.
- The disc menu appears on the TV.
- Playback will start automatically. If not, press ► (PLAY).



- 2 If the disc main menu contains various folders, use the ▲/▼ keys to select a desired folder and press ENTER to open the folder.
- 3 Use the ▲/▼ keys to select a track/file and press ENTER to start playback.
 - Playback will start from the selected file and continue through to the end of the folder.

During playback, you can;

- Press ◀◀/▶▶ to playback another track/file in the current folder.
- To select another folder from the current disc, press ▲ to return to the root menu. Use the ▲/▼ keys to make your selection and press ENTER to confirm.
- Press REPEAT repeatedly to access various play modes.
 - OFF
 - TRACK REPEAT: One file will be played repeatedly.
 - DISC REPEAT: All files in one folder will be played repeatedly.

Tip

- To skip the folders menu when you load a MP3/JPEG disc, set the MP3/JPEG NAV setting in the Preference Setup Page to WITHOUT MENU.

Note

- Some discs cannot be played on this player due to the configuration and characteristics of the disc, or due to the condition of recording and authoring software that was used.

Playing an MP3/DivX/JPEG/Windows Media™ Audio disc

This DVD system can playback most of the MP3, JPEG and Windows Media™ Audio files recorded on a CD-R/RW disc or commercial CD.

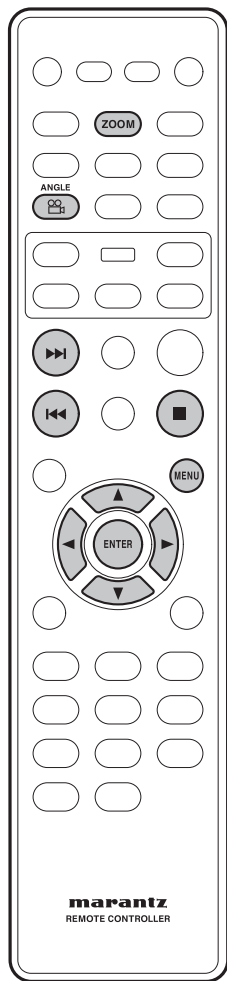

Playing a JPEG image file (slide show)

- Insert a Picture disc (Kodak Picture CD, JPEG).
For a Kodak disc, the slide show will begin automatically.
For a JPEG disc, the picture menu will appear on the TV. Press PLAY ► to start the slide-show playback.

Note
Some discs don't allow the Picture menu.

Preview function

- 1 During playback, press ■.
 - 12 thumbnail pictures will be displayed on the TV.



- 2 Press ◀◀/▶▶ to display the other pictures on the previous/next page.
- 3 Use the ◀/▶/▲/▼ keys to highlight one of the pictures and press ENTER to start playback.
- 4 Press the MENU to return to Picture CD menu.

Zoom picture

- 1 During playback, press ZOOM repeatedly to select a different zoom factor.
- 2 Use the ◀/▶/▲/▼ keys to pan through the zoomed image.

Tip

- This feature is not applicable for DivX discs.
- Zoom play cannot be used on some discs.

Rotating/flipping the picture

- During playback, use the ◀/▶/▲/▼ keys to rotate/flip the picture on the TV.
 - ▲: Flip the picture vertically
 - ▼: Flip the picture horizontally
 - ◀: Rotate the picture counter-clockwise
 - ▶: Rotate the picture clockwise

Note

- Rotate and Flip operations are not supported on DVD-Audio disc.

Scan Effect

- Press ANGLE repeatedly to choose a scan effect.
- Various scan effects appear in the top left corner of the TV screen.

Note
Supported file format:

- The file extension has to be "*.JPG" and not "*.JPEG".
- It can only display DCF-standard still pictures or JPEG pictures e.g. TIFF. It cannot play back moving pictures, Motion JPEG and other formats, or pictures in formats other than JPEG, or pictures associated with sound.
- It may require longer time for the DVD system to display the disc content on the TV due to the large number of songs/pictures compiled into one disc.

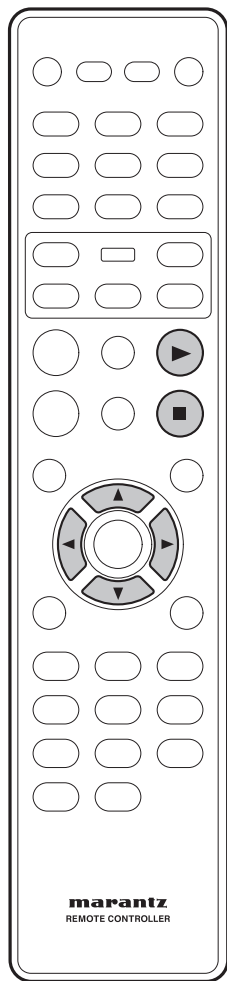

Playing MP3/WMA music and JPEG pictures simultaneously

You can create a musical slide show if the disc contains both the MP3/WMA music and JPEG picture files.

- 1 Insert an MP3/WMA disc that contains music and pictures.
- 2 Select an MP3/WMA track in the menu and press **PLAY ►** to start playback.
- 3 During MP3/WMA music playback, use the **◀/▶/▲/▼** keys to select a picture folder from the disc menu and press **PLAY ►**.
 - The picture files will be played back through to the end of the folder.
- 4 To stop simultaneous playback, press **STOP ■**.

Tip

- It is normal to experience an occasional “skip” while listening to your MP3 disc.
- It is normal to experience an occasional pixelation during MP3/DivX playback due to poor clarity of digital contents during internet downloading.
- Only the first session of a multi-session CD will be played back.

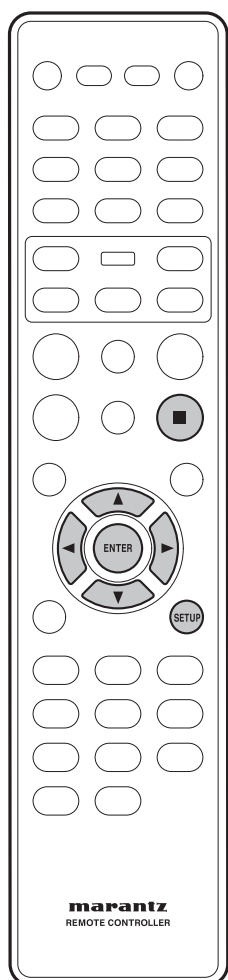

Using the Setup Menu

Before using the player, you should specify the settings to be used in accordance with the conditions under which the player is to be used.

Note that once changed, the settings will be saved and remain the same even after the power has been turned off until the settings are changed again.

The Setup menu gives you access to all the player's settings. Press **SETUP** to display/leave the menu and the cursor and **ENTER** buttons on the remote control to navigate and select options.

Note

- The language options shown in the on-screen display illustrations on the following pages may not correspond to those available in your country or region.

1 Press the **SETUP** button on the remote control. Select a tab using the cursor buttons (◀/▶).

- ① **GENERAL SETUP:** Setup of the GENERAL options
- ② **AUDIO SETUP:** Setup of the audio options
- ③ **VIDEO SETUP:** Setup of the display and HDMI Video options
- ④ **PREFERENCE:** Setup of the language, parental, and several other options.

2 Use the cursor buttons (▲/▼) on the remote control to access the different features.

3 Press the **ENTER** button as many times as necessary to select the desired option.

To make the setup screen disappear after setting up, press the **SETUP** button again.

Note

- Depending on the disc, some Setup Menu selections may not work.
- Some settings can not be selected during playback and RESUME mode of DVD-Video. In that case, press the **■ (STOP)** button once or twice to stop playback completely.

DVD Setup Menu

6

English

A black dot (●) indicates the default setting

* It can be set only during STOP.

		Page	
GENERAL SETUP	OSD LANGUAGE	● ENGLISH ESPANOL FRANCAIS 34	
	PLAYER MODE	● DVD AUDIO DVD VIDEO 34	
	DIVX(R) VOD CODE	35	
	DISC LOCK *	LOCK ● UNLOCK 35	
	DISPLAY DIM	● 100% 70% 40% 35	
	PROGRAM *	INPUT MENU 35	
	SCREEN SAVER	● ON OFF 36	
	SLEEP	15 MINS 30 MINS 45 MINS 60 MINS ● OFF 36	
	AUTO STANDBY	● ON OFF 36	
	AUDIO SETUP	AUDIO OUT	2 CHANNEL VIRTUAL SURROUND ● 5.1 CHANNEL 37
DIGITAL AUDIO		DIGITAL OUT	OFF ● ALL PCM 39
		LPCM OUT	● 48KHZ 96KHZ 39
HDMI AUDIO OUT		● AUTO MULTI PCM 2CH PCM OFF 39	
SPEAKER SETUP		SPEAKER SETUP PAGE	
		FRONT L/R	● LARGE SMALL
		CENTER	OFF ● LARGE SMALL
		REAR LS/RS	OFF ● LARGE SMALL
		LFE (SUBWOOFER)	● ON OFF
		SPEAKER LEVEL	40
	FRONT LEFT FRONT RIGHT CENTER LFE REAR LEFT		
	REAR RIGHT		
	SPEAKER DISTANCE		
	FRONT LEFT FRONT RIGHT CENTER LFE REAR LEFT		
	REAR RIGHT		
CD UPSAMPLING	● OFF 88.2KHZ(X2) 176.4KHZ(X4) 41		
AUDIO DRC	ON ● OFF 41		
VIDEO SETUP	TV SYSTEM	PAL NTSC MULTI 42	
	TV ASPECT	4:3 PAN SCAN 4:3 LETTER BOX ● 16:9 WIDE 43	
	PROGRESSIVE	● OFF ON 43	
	PICTURE SETTING	● STANDARD BRIGHT SOFT 44	
		PERSONAL BRIGHTNESS SHARPNESS CONTRAST TINT	44
	ADV PICTURE	DCDI	OFF ● ON
		GAMMA	
		CHROMA DELAY	
		PSCAN FORMAT	SUPER WIDE 16:9 SQUEEZE ● OFF
		HDMI VIDEO	480P 576P 720P 1080I 1080P ● AUTO 45
	DYNAMIC PICTURE	46	
	DVI OUTPUT RANGE	ENHANCED ● STANDARD	
COMPONENT	YCbCr ● RGB 46		
BLACK LEVEL	7.5 IRE 0 IRE 46		
CLOSED CAPTION	ON ● OFF 46		
PREFERENCE	AUDIO	● ENGLISH CHINESE (SIMP) FRENCH SPANISH etc. 47	
	SUBTITLE	● OFF ENGLISH CHINESE (SIMP) FRENCH SPANISH etc. 47	
	DISC MENU	● ENGLISH CHINESE (SIMP) FRENCH SPANISH etc. 48	
	PARENTAL	1 KID SAFE 2 G 3 PG 4 PG13 5 PGR 6 R 7 NC17 ● 8 ADULT 48	
	PBC	● ON OFF 48	
	MP3/JPEG NAV	WITH MENU ● WITHOUT MENU 48	
	VR LIST	● ORIGINAL LIST PLAY LIST 48	
	PASSWORD	CHANGE 49	
	DIVX SUBTITLE	● STANDARD CYRILLIC 49	
	DEFAULT	RESET 50	

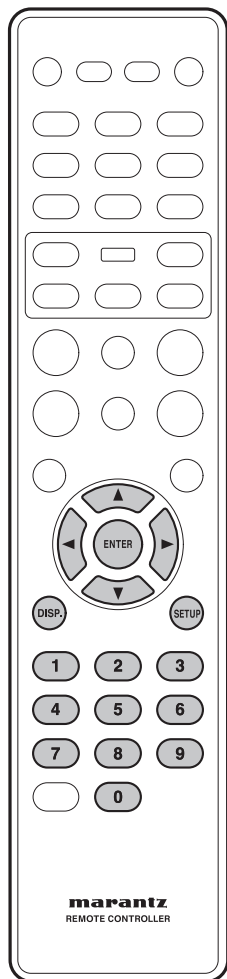

Setting up the GENERAL SETUP page

- 1 Press the **SETUP** button.
- 2 Select **GENERAL SETUP PAGE** using the cursor buttons (**◀/▶**), then press the **ENTER** button.

- 3 Use the cursor buttons (**▲/▼**) to select the desired item, then press the cursor (**▶**) or **ENTER** button.

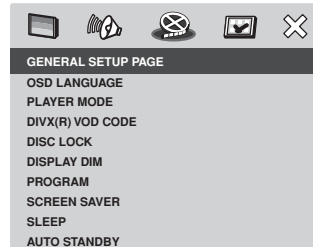

Note

- Press **◀** to go back to the previous menu item.
Press **SETUP** to exit the menu.

OSD LANGUAGE

The language options are different depending on your country or region, and may not match the illustrations shown in the user manual.

- Default setting: **ENGLISH**

The OSD (On-Screen Display) language for this DVD system will remain as you have set it, regardless of the changes made to the DVD disc language.

Selects the preferred language for the DVD system on-screen display menu.

PLAYER MODE

- Default setting: **DVD AUDIO**
- **DVD Audio**
Should be selected when the player is to be used as a DVD audio player.
- **DVD Video**
Should be selected when the player is to be used as a DVD video player.

Note

- Some DVD-Audio discs contain bonus groups that are accessible by a four-digit password. In this case, consult the disc jacket and other packaging for information.

- ① **During play, press DISPLAY twice.**
 - The group and track list is displayed on the TV screen.
- ② Press **◀/▶** to select a bonus group, then press **ENTER**.
- ③ Enter a four-digit password using the numeric keypad (0-9), then press **ENTER**.
- ④ Set will start to playback the bonus group.

DivX(R) VOD CODE

MARANTZ provides you with the DivX® VOD (Video On Demand) registration code that allows you to rent and purchase videos using the DivX® VOD service. Press ► to see the registration code and press ENTER to exit.

Use the registration code to purchase or rent the videos from the DivX® VOD service at www.divx.com/vod. Follow the instructions and copy the video from your computer onto a CD-R/RW disc for playback on this DVD system.

Note

- Any video downloaded from DivX® VOD can only be played back on this DVD system. For more information, visit us at www.divx.com/vod.
- The time search function is not available during DivX movie playback.

DISC LOCK

- Default setting: **UNLOCK**

Not all discs are rated or coded by the disc maker. You can prevent a specific disc from playing by locking the disc. Up to 40 discs can be locked.

- **LOCK** – Selects this to block the playback of the current disc. Subsequent access to a locked disc requires a six-digit password. The default password is “111111”.
- **UNLOCK** – All discs can be played.

DISPLAY DIM

- Default setting: **100%**

Selects the brightness of the DVD system display panel.

- **100%** – Full brightness.
- **70%** – Medium brightness.
- **40%** – Dimmest display.

PROGRAM

(DVD-Video) (DVD-Audio) (Video-CD) (CD)

You can play the contents of the disc in the order you want by programming the playing order of the tracks. You can store up to 20 tracks.

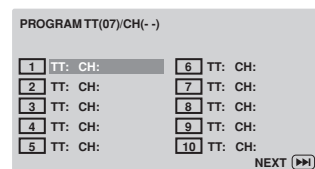

- 1 Use the numeric keypad (0-9) to enter a valid track/chapter number.
- 2 Use the ◀/▶/▲/▼ keys to move the cursor to the next position.
 - If there are more than ten total programme tracks, select **NEXT** on the screen (or press ►► on the remote control) and press **ENTER** to access the next programming page.
- 3 To remove the track/chapter from the programming menu, select the track/chapter and press **ENTER**.
- 4 Once complete, select **START** on the screen and press **ENTER** to start playback.
 - Playback will start from the selected track under the programmed sequence.
- 5 To exit the programme menu, select **EXIT** in the menu and press **ENTER**.

Note

- On Super Audio CD discs, you can program tracks on the CD layer.
- When playing back to program, previous **RANDOM** and **repeat** modes are all cancelled.
- When in **VCD 2.0 mode (PBC ON mode)**, this function does not work.
- **DVD-VR** can not be programmed.
- **DVD-Audio Bonus Group/Tracks** can not be programmed.

SCREEN SAVER

- Default setting: **ON**

The screen saver prevents damage to the TV screen by avoiding exposure to a static image for too long.

- **ON** – Switches to TV screen saver mode when playback has been stopped or paused for more than 15 minutes.
- **OFF** – Turns off the screen saver function.

SLEEP

- Default setting: **OFF**

This feature automatically sets the DVD player in standby mode after the period you set has elapsed.

You can select from 15, 30, 45, and 60 minutes. Select **OFF** to cancel the sleep timer function.

Press **ENTER** to confirm your selection.

AUTO STANDBY

- Default setting: **ON**

If **ON** is selected, the standby mode is automatically selected to save power if the player is left in the Stop mode for about 30 minutes.

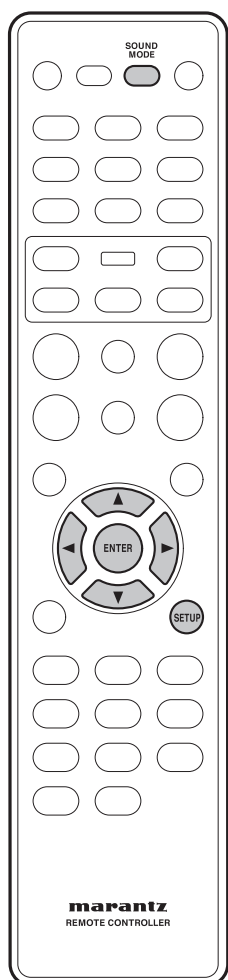

- 3 Use the cursor buttons (▲/▼) to select the desired item, then press the cursor (▶) or ENTER button.

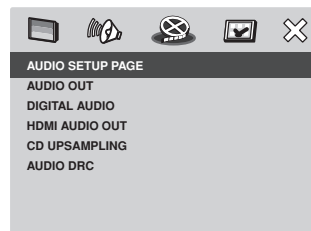

 **Note**

- Press ◀ to go back to the previous menu item. Press SETUP to exit the menu.

AUDIO OUT

If you connected this player to your amplifier using the 5.1 channel analog outputs (front, surround, center and subwoofer outs), set this to **5.1 Channel**; if you connected only the stereo outputs, set to **2 Channel**.

- **Default setting: 5.1 CHANNEL**
- **2 CHANNEL** – Select this to change the channel output to stereo, which only delivers sound from the two front speakers and a subwoofer.
- **VIRTUAL SURR** – Select this to virtually reproduce the surround channels.
- **5.1 CHANNEL** – Select this setting when using a multichannel audio/(video) receiver with 6 channel inputs. In this mode, the player performs DTS decoding or Dolby Digital 5.1-channel decoding when applicable, and Dolby Pro Logic decoding on DVD-Video, Video-CD and Audio CD discs with 2-channel sound tracks. No Dolby Pro Logic decoding is done with Super Audio CD discs.

 **Note**

- You can also select it using the SOUND MODE buttons on the remote control.
- Some DVD-Audio discs don't allow downmixing of audio.

Setting up the AUDIO SETUP page

- 1 Press the **SETUP** button.
- 2 Select **AUDIO SETUP PAGE** using the cursor buttons (◀/▶), then press the **ENTER** button.

About source audio output

When the source output mode has been switched among 2CH, Virtual Surround and 5.1 CH mode setting using the Audio Out setting, audio output for each source will be as shown in the following table.

Audio Contents		Audio Out Setting	Mixed 2ch output	5.1CH output	Digital output
DVD	Dolby Digital (2CH)	2 CH	2ch L/R	2ch L/R	PCM (Digital out is PCM) Bitstream (Digital out is All)
		Virtual Surround	2ch L/R	2ch+Vsurround	
		5.1 CH	2ch L/R	Dolby Pro Logic II	
	Dolby Digital (Multi CH)	2 CH	Mixed 2ch (L0/R0)	Mixed 2ch (L0/R0)	PCM Mixed 2CH (Digital out is set to PCM) Bitstream (Digital out is set to All)
		Virtual Surround	Mixed 2ch (Lt/Rt)	Mixed 2ch+Vsurround	
		5.1 CH	Mixed 2ch (Lt/Rt)	Multi CH	
	LPCM (2CH)	2 CH	2ch L/R	2ch L/R	PCM 2ch 44.1/48KHz (88.2/96KHz if LPCM OUT is set to 96KHz.)
		Virtual Surround	2ch L/R	2ch+Vsurround	
		5.1 CH	2ch L/R	Dolby Pro Logic II	
	DTS, DVD-Video/Audio (2CH), CD	2 CH	2ch L/R	2ch L/R	PCM (Digital out is PCM) Bitstream (Digital out is All)
		Virtual Surround	2ch L/R	2ch+Vsurround	
		5.1 CH	2ch L/R	2ch L/R	
	DTS, DVD-Audio (Multi)	2 CH	Mixed 2ch (L0/R0)	Mixed 2ch (L0/R0)	PCM Mixed 2CH (Digital out is set to PCM) Bitstream (Digital out is set to All)
		Virtual Surround	Mixed 2ch (Lt/Rt)	Mixed 2ch+Vsurround	
		5.1 CH	Mixed 2ch (Lt/Rt)	Multi CH	
	MPEG (MULTI)	2 CH	Mixed 2ch (L0/R0)	Mixed 2ch (L0/R0)	PCM (Digital out is PCM) Bitstream (Digital out is All)
		Virtual Surround	Mixed 2ch (Lt/Rt)	Mixed 2ch+Vsurround	
		5.1 CH	Mixed 2ch (Lt/Rt)	Multi CH	
	DVD-Audio (2CH)	2 CH	2ch L/R	2ch L/R	PCM 2CH (see page 40)
		Virtual Surround	2ch L/R	2ch L/R	
		5.1 CH	2ch L/R	2ch L/R	
	DVD-Audio (Multi)	2 CH	2ch (Lf/Rf)	2ch (Lf/Rf)	PCM 2ch (Lf/Rf) (see page 40)
		Virtual Surround	2ch (Lf/Rf)	2ch (Lf/Rf)+Vsurround	
		5.1 CH	2ch (Lf/Rf)	Multi CH	
CD	2 CH	2ch L/R	2ch L/R	PCM 2ch 44.1KHz	
	Virtual Surround	2ch L/R	2ch+Vsurround		
	5.1 CH	2ch L/R	Dolby Pro Logic II		
Super Audio CD	2ch	2 CH	2ch L/R	2ch L/R	OFF
		Virtual Surround	---	---	OFF
		5.1 CH	---	---	OFF
	Multi	2 CH	---	---	OFF
		Virtual Surround	---	---	OFF
		5.1 CH	Mixed 2ch (Lt/Rt)	Multi CH	OFF
Video CD S-Video CD 2ch	2 CH	2ch L/R	2ch L/R	PCM 2ch 44.1KHz	
	Virtual Surround	2ch+Vsurround	2ch+Vsurround	PCM 2ch 44.1KHz + Vsurround	
	5.1 CH	Mixed 2ch	Dolby Pro Logic II	PCM 2ch 44.1KHz	
MP3/DivX,WMA	2 CH	2ch L/R	2ch L/R	PCM 2CH	
	Virtual Surround	2ch L/R	2ch+Vsurround		
	5.1 CH	2ch L/R	Dolby Pro Logic II		

Note

- No Dolby Pro Logic II is allowed on DTS, DVD-Audio and Super Audio CD audio track.
- LFE (Subwoofer) will always carry the LFE channel.

DIGITAL OUT

- Default setting: **ALL**

Set the Digital output according to your optional audio equipment connection.

- **OFF** – Turn off the digital output.
- **ALL** – If you have connected your DIGITAL AUDIO OUT to a multi-channel decoder/receiver.
- **PCM ONLY** – Only if your receiver is not capable of decoding multi-channel audio.

 **Note**

- If HDMI is activated, DIGITAL OUT is muted. HDMI audio out is related to the “DIGITAL OUT” setting. If set the “ALL” is set, HDMI Audio out is follows the EDID. If set the “PCM” is set, HDMI Audio out is always PCM.
- If you set to “ALL” with a non-DTS compatible amplifier, noise will be output when you play a DTS disc.

LPCM OUT

- Default setting: **48kHz**

If you connect the DVD Player to a PCM compatible receiver via digital terminals, coaxial or optical, you may need to adjust “LPCM Output”. Discs are recorded at a certain sampling rate. The higher the sampling rate, the better the sound quality.

- **48kHz** – Playback a disc recorded at the sampling rate of 48 kHz. A 96 kHz (if available on disc) PCM data stream will be converted to 48 kHz.
- **96kHz** – Playback a disc recorded at the sampling rate of 96 kHz. If the 96 kHz disc is copy-protected, the digital output will automatically be converted to a sampling rate of 48 kHz.

 **Note**

- High sampling rate DVD-Audio discs (192 kHz or 176.4 kHz) always output audio that has been down sampled to 96 kHz or 88.2 kHz through the digital outputs, when LPCM OUT is set to 96 kHz.

HDMI AUDIO OUT

- Default setting: **AUTO**

- **AUTO** – In this mode, when discs recorded in Dolby Digital, DTS, or MPEG are played, the respective bit stream signal is output. When DVD-Video/DVD-Audio discs with multi-channel audio are played, the multi-channel signal is output. When discs recorded in 2-channel PCM or other 2-channel format are played, the audio is output as 2-channel PCM. The output formats are limited by the capabilities of the connected component. For example, if the disc is recorded in Dolby Digital but the connected component does not support Dolby Digital, the audio is output as multi-channel PCM. If the connected component does not support multi-channel PCM either, the audio is output as 2-channel PCM.
- **Multi PCM** – In this mode, when discs recorded in Dolby Digital, DTS, MPEG, or DVD-Video/DVD-Audio are played, a multi-channel signal is output. When discs recorded in 2-channel PCM or other 2-channel format are played, the audio is output as 2-channel PCM. The output formats are limited by the capabilities of the connected component. For example, if the disc is recorded in Dolby Digital but the connected component does not support Dolby Digital, the audio is output as 2-channel PCM.
- **2ch PCM** – In this mode, audio is output as 2-channel PCM for all discs. Select this mode when the unit is connected to a TV or projector.
- **Off** – Audio signals are not output from the HDMI jack.

 **Note**

- When audio signals are being output by HDMI-compatible components, digital output signals are muted.
- If HDMI is activated, DIGITAL OUT is muted. HDMI audio out is related to the “DIGITAL OUT” setting. If set to “ALL”, HDMI Audio out is follows the EDID. If set to “PCM”, HDMI Audio out is always PCM.
- Audio is not output when the player is connected to a device with an HDCP-compatible DVI jack.

HDMI Audio Output

Auto formats		HDMI Setting (Audio)			
		Auto ^{*1}	Multi PCM ^{*2}	2 ch PCM	Off
DVD	Dolby Digital	Dolby Digital	Multi channel PCM	2 Channel DOWNMIX	Not Output
	Linear PCM	Multi channel PCM	Multi channel PCM	2 Channel DOWNMIX	Not Output
	DTS	DTS	Multi channel PCM	2 Channel DOWNMIX	Not Output
	MPEG	MPEG	Multi channel PCM	2 Channel DOWNMIX	Not Output
DVD-Audio		Multi channel PCM	Multi channel PCM	2 Channel DOWNMIX ^{*3}	Not Output
CD/MP3/Super Audio CD ^{*4}		Left/Right			Not Output
DTS CD		DTS	Multi channel PCM	2 Channel DOWNMIX	Not Output
Video CD		Left/Right			Not Output

^{*1}: The order of priority in **Auto** mode is: **Bit Stream, Multi PCM, 2ch PCM.**

The output format is limited by the capabilities of the connected component.

^{*2}: The order of priority in **Multi PCM** mode is: **Multi PCM, 2ch PCM.**

The output format is limited by the capabilities of the connected component.

^{*3}: Audio is not output from discs that prohibit downmixing.

^{*4}: Audio is not output from Super Audio CDs. Audio is only output when a CD layer is played.

SPEAKER SET UP

You can adjust the delay times (for center and surround speakers only) and the volume level for individual speakers. These adjustments let you optimize the sound of your system to best suit your surroundings and setup.

**IMPORTANT**

- Speaker settings are only available for multi-channel audio output.

FRONT SPEAKER, CENTER SPEAKER, REAR SP

- **OFF** (only for **CENTER** and **REAR** speakers) – Select when no speakers are connected.
- **LARGE** – Select if the main speaker cone is 12 cm or more.
- **SMALL** – Select if the main speaker cone is less than 12 cm.

LFE (SUBWOOFER)

- **ON** – Select when a subwoofer is connected.
- **OFF** – Select when no subwoofer is connected.

SPEAKER LEVEL

Volume level setting for individual speakers (–6 dB to +6 dB).



SPEAKER DISTANCE

Delay time settings in relation to the listening position/distance for individual speakers (1.0 MS to 9.0 MS).

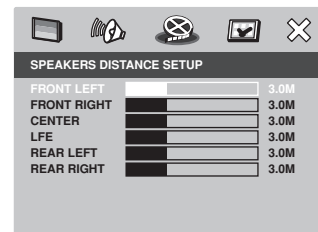

 **Note**

- Use a longer delay time setting when the surround speakers are closer to the listener than the front speakers.
- A test tone will be automatically generated to help you judge the sound level of each speaker.

CD UPSAMPLING

- **Default setting: OFF**

This feature allows you to convert your music CD to a higher sampling rate using sophisticated digital signal processing for better sound quality. If you have activated the upsampling function, the player will automatically switch to stereo mode.

- **OFF** – Select this to disable CD upsampling.
- **88.2kHz (X2)** – Select this to convert the sampling rate of CDs to twice that of the original.
- **176.4kHz (X4)** – Select this to convert the sampling rate of CDs to four times that of the original.

 **Note**

- This setting is only valid for signals output from the analog jacks.
- CD upsampling is switched to **OFF**, if **AUDIO OUT** is set to **Vsurround** and **5.1CH**.
- **AUDIO OUT** is switched to **2CH**, if CD upsampling is set to 88.2 kHz or 176.4 kHz.

AUDIO DRC

- **Default setting: OFF**

This mode optimizes playback of sound at low volume. High volume outputs will be softened and low volume outputs will be enhanced to an audible level. This feature is only applicable for DVD video discs with Dolby Digital mode.

- **ON** – Turns on AUDIO DRC mode.
- **OFF** – Turns off AUDIO DRC mode.
Select this to enjoy the sound with its full dynamic range.

 **Note**

- Audio DRC is only effective with Dolby Digital Audio sources.

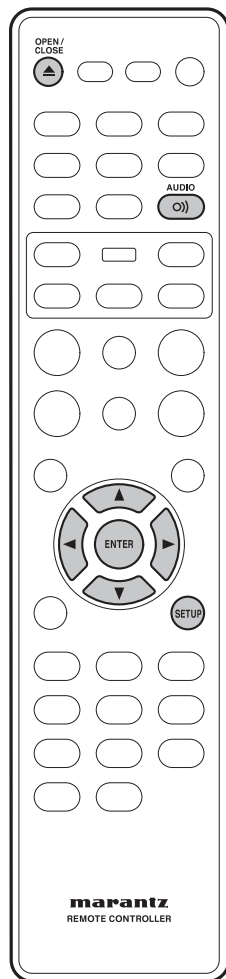

Setting up the VIDEO SETUP page

- 1 Press the **SETUP** button.
- 2 Select **VIDEO SETUP PAGE** using the cursor buttons (**◀/▶**), then press the **ENTER** button.
- 3 Use the cursor buttons (**▲/▼**) to select the desired item, then press the cursor (**▶**) or **ENTER** button.

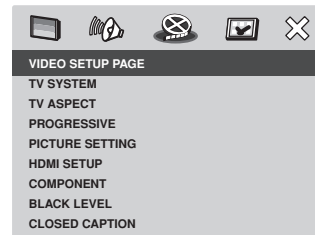

Note

- Press **◀** to go back to the previous menu item.
Press **SETUP** to exit the menu.

TV SYSTEM

- Default setting: **NTSC (USA model)**
PAL (Europe model)

The colour system of the DVD system, DVD and TV should match: only then will it be possible to play a DVD on this system. Before changing the TV system, determine the colour system of your TV.

- **PAL** – Select this if the connected TV has the PAL colour system. It will change the video signal of an NTSC disc and output it to PAL format.
- **NTSC** – Select this if the connected TV has the NTSC colour system. It will change the video signal of a PAL disc and output it to NTSC format.
- **MULTI** – Select this if the connected TV is compatible with both NTSC and PAL (multi-system). The output format will be in accordance with the video signal of the disc.

Select one of the options and press **ENTER** to confirm.

- Follow the instructions shown on the TV to confirm the selection (if any).
- If a blank/distorted TV screen appears, wait for 15 seconds for the auto recovery.

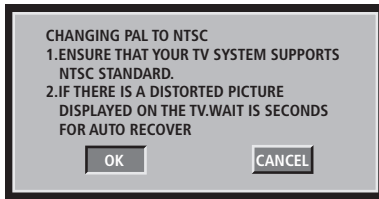

Video output format when progressive is "ON".

Disc Format	TV system	Output Format	
		YCbCr	Video/S-Video
NTSC	PAL	PAL Progressive	NTSC
	NTSC	NTSC Progressive	NTSC
	MULTI	NTSC Progressive	NTSC
PAL	PAL	PAL Progressive	PAL
	NTSC	NTSC Progressive	PAL
	MULTI	PAL Progressive	PAL

If progressive is "OFF", Video Output Format follow the TV SYSTEM with Interlace.

To change the TV system manually:

- 1 Press OPEN CLOSE \blacktriangle to open the disc tray without HDMI connected.
- 2 Press \blacktriangleright (RIGHT) on the remote control.
- 3 Press AUDIO on the remote control to change the TV system setting.
PAL \rightarrow NTSC
NTSC \rightarrow PAL
MULTI \rightarrow depends on the disc

TV ASPECT

- Default setting: 16:9 WIDE

Set the aspect ratio of the DVD system according to the TV type you have connected. The format you select must be available on the disc. If it is not, the setting for TV display will not affect the picture during playback.

- 4:3 PAN SCAN – Select this if you have a conventional TV and want both sides of the picture to be trimmed or formatted to fit your TV.



- 4:3 LETTER BOX – Select this if you have a conventional TV. In this case, a wide picture with black bands on the upper and lower portions of the TV will be displayed.



- 16:9 WIDE – Select this if you have a wide-screen TV.



Select one of the options and press ENTER to confirm.

Note

- Some discs will not allow you to change the aspect ratio.

PROGRESSIVE

- Default setting: OFF

Progressive scanning displays twice the number of frames per second as interlaced scanning (ordinary normal TV system). With nearly double the number of lines, progressive scanning offers higher picture resolution and quality.

Before you start...

Ensure that you have connected this DVD system to a progressive scan TV using the YCbCr connection (see page 11 "Home theater video connections").

- ON – Turns on progressive scan mode.

The instruction menu appears on the TV.

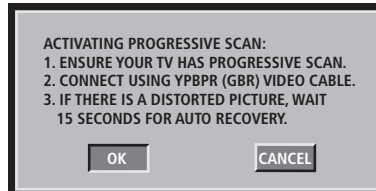

- 1 Press \blacktriangleleft to highlight "OK" in the menu and press ENTER to confirm.

The picture on your TV will remain distorted in this state until you turn on the progressive scan mode on your TV.

- 2 Turn on your TV's progressive scan mode (refer to the user manual for your TV.) The following menu appears on the TV.

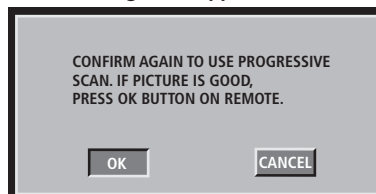

- ③ Press **◀** to highlight **OK** in the menu and press **ENTER** to confirm.

The set-up is complete now and you can start to enjoy the high quality picture.

- **OFF** – Disables the progressive scan mode.

To deactivate Progressive manually:

- ① Press **OPEN CLOSE ▲** to open the disc tray without **HDMI** connected.

- ② Press **◀ (LEFT)** on the remote control. Press **AUDIO** on the remote control.

The DVD background screen appears on the TV.

Tip

- There are some progressive scan TVs and high-definition TVs that are not fully compatible with this unit, resulting in an unnatural picture when playing back a DVD Video disc in the progressive scan mode. In this case, turn off the progressive scan feature on both the DVD system and your TV.

PICTURE SETTING

- Default setting: **STANDARD**

This DVD system provides three predefined sets of picture colour settings and one personal setting which you can define yourself.

- **STANDARD** – Original colour setting.
- **BRIGHT** – Vibrant colour setting.
- **SOFT** – Warm colour setting.
- **PERSONAL** – Selects this to personalize the picture colour setting. Use the **◀/▶** keys to select to the setting that best suits your personal preference and press **ENTER** to confirm. For an average setting, select **0**.
 - **BRIGHTNESS** – Increase the value to brighten the picture or vice versa.
 - **SHARPNESS** – Increase the value to sharpen the picture or vice versa.
 - **CONTRAST** – Increase the value to sharpen the picture or vice versa.
 - **TINT** – Increase the value to darken the picture or vice versa.
 - **COLOR** – Increase the value to enhance the color in your picture or vice versa.

ADV PICTURE

This player allows you to fine-tune the following video parameters.

We recommend setting the aspect ratio on your TV if the function is available.

DCDi

- Default setting: **ON**

DCDi (Directional Correction Deinterlacing) computes and tracks the angle of the screen edge to fill in missing pixels on the TV screen. DCDi will optimize the image quality significantly, especially during slow motion playback. This function is available only for progressive scan output.

- **OFF** – Select to deactivate this function.
- **ON** – Select to activate this function.

GAMMA

Enables you to non-linearly adjust the intensity of the picture. A positive value enables you to bring out low level detail in dark scenes, while a negative value emphasizes contrast. This function is not available when using an HDMI compatible component.

-7 to +7

CHROMA DELAY

The chroma (color) and luminance (brightness) signals are not synchronized. The Chroma Delay setting allows you to adjust the advance delay of the chroma signal to yield a perfectly clear picture. This function is not available when using an HDMI-compatible component.

-3 to +3

PSCAN FORMAT

- Default setting: **OFF**

Set the aspect ratio of the projected images on the screen. This function is only available for progressive scan and HDMI video output.

- **SUPER WIDE** – Select this to display a 4:3 picture disc on a wide-screen TV with non-linear stretching (the centre position of the screen is stretched less than the side).
- **16:9 SQUEEZE** – Select this to display a 4:3 picture disc on a widescreen TV without stretching. Black bars will be shown on the both sides of the TV screen.
- **OFF** – No aspect ratio adjustment is made when this option is selected.

HDMI VIDEO

- Default setting: **AUTO**

Selects a suitable video resolution depending on the capability of the connected TV/device to enhance the HDMI video output.

- **480P** – Progressive output in 480 lines for NTSC TV
- **576P** – Progressive output in 576 lines for PAL TV
- **720P** – Progressive output upscaled to 720 lines
- **1080i** – Interlaced output upscaled to 1080 lines
- **1080P** – Progressive output upscaled to 1080 lines
- **AUTO** – The video output will automatically follow the display's supported resolution

Note

- If no display appears on the TV due to an unsupported resolution, use the composite video cable to connect the DVD system and your TV. Turn on your TV to the correct input channel for the composite video and adjust the resolution setting to **480P/576P**.
- The resolution can also be set with the **HDMI** button on the front panel.
- In general, the larger the number, the higher the resolution.
- When the resolution is changed, the image may be corrupted or the output may take longer than normal.
- Pressing the HDMI button for three seconds or more toggle the HDMI on/off state (see **pages 13, 14**).
- 720P/1080i/1080P only supports 60 Hz Video signal.

Setup Examples

Resolution (HDMI Setting)	Playback Disc			
	Disc Recorded in Squeeze Ratio		Disc Recorded in 4:3 Ratio	
	TV ASPECT	Monitor Setting	TV ASPECT	Monitor Setting
480P 576P	16:9 WIDE	Full/Squeeze	SUPERWIDE	Standard
720P		Normal/Through	16:9 SQUEEZE	Normal
1080i 1080P			OFF ^{*1}	4:3 Through
AUTO	The resolution is automatically selected to match the monitor you are using. Set TV SYSTEM, PSCAN FORMAT and your monitor setting to match the selected resolution.			

Some monitors may use setting names that are different than those shown here.

^{*1} If the aspect ratio you desire is not available, select the most suitable setting from **SUPERWIDE, 16:9 SQUEEZE** and **OFF** in "PSCAN FORMAT".

Video Out format when HDMI is activated

HDMI Video Output	YCbCr Output		Video/S-Video output
	Progressive ON	Progressive OFF	
480P	480P (NTSC progressive)	Follow the Disc Source with Interlace. (ex: NTSC disc play: NTSC interlace)	
576P	576P (PAL progressive)		
720P	No Video		
1080i			
1080P			

DYNAMIC PICTURE

Produces more dynamic picture by increasing the picture contrast and the color intensity. This function is available only for progressive scan output.

0 to 5**DVI OUTPUT RANGE**

- Default setting: **STANDARD**

When connecting the DVI unit, black may rise to the surface depending on the display.

- **ENHANCED** – Image data values between 0 (black) and 255 (white)
- **STANDARD** – Image data values between 16 (black) and 235 (white)

COMPONENT**(Euro model only)**

- Default setting: **RGB**

This setting allows you to toggle the output of the video signal between RGB (on the A/V EURO CONNECTOR) and YCbCr (on the component).

- **YCbCr** – Select this for YCbCr Pr connection on component Video out.
- **RGB** – Select this for the A/V EURO CONNECTOR.

To change the COMPONENT out manually:

- 1 Press **OPEN CLOSE**  to open the disc tray without HDMI connection.
- 2 Press **▶ (RIGHT)** on the remote control.
- 3 Press **ANGLE** on the remote control to change the COMPONENT out.

**Note**

- When the player is set to YCbCr, some TV may not properly synchronize with the player on the A/V EURO connector.

BLACK LEVEL

- Default setting: **7.5 IRE (USA model)**
0 IRE (European model)

If you set the TV type to NTSC, set the Black level shift to 7.5 IRE. This will improve the color contrast during playback. The black level setting has no effect if the TV type is set to PAL.

- **7.5 IRE** – Select this to enhance the black level.
- **0 IRE** – Select this for the standard black level setting.

CLOSED CAPTION (USA Model only)

- Default setting: **OFF**

Closed captions are data hidden in the video signals of specific discs, and are invisible without the use of a special decoder. The difference between subtitles and captions is that subtitles are intended for hearing persons and captions are for the hearing impaired. Subtitles rarely show all of the audio. For example, captions show sound effects (e.g., “phone ringing” and “footsteps”), while subtitles do not. Before you select this function, please ensure that the disc contains closed caption information and your TV set also supports this function.

- **ON** – Select this to enable the closed caption function.
- **OFF** – Select this to disable the closed caption function.

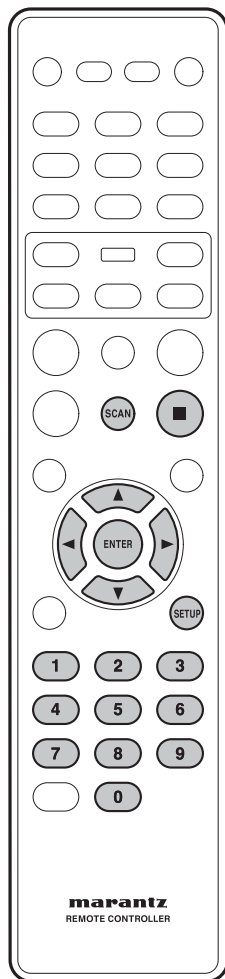

Setting up the PREFERENCE page

- 1 Press ■ (STOP) twice to stop playback (if any), then press SETUP.
- 2 Select PREFERENCE PAGE using the cursor buttons (◀/▶), then press the ENTER button.
- 3 Use the cursor buttons (▲/▼) to select the desired item, then press the cursor (▶) or ENTER button.

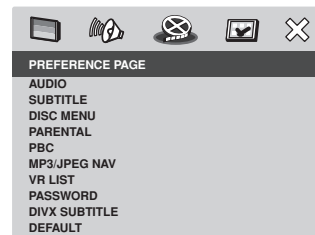

Note

- Press ◀ to go back to the previous menu item.
Press SETUP to exit the menu.

Using the AUDIO, SUBTITLE and DISC MENU language

You can select your preferred language settings for DVD playback. If the selected language is recorded on the DVD disc, the DVD system will automatically play the disc in that language. Otherwise, the disc's default language will be used instead.

AUDIO

Selects the preferred audio language for DVD playback.

- Default setting: **ENGLISH**

If the language you want is not in the list, select **OTHERS**, then use the numeric keypad (0-9) on the remote to enter the 4-digit language code "XXXX" (see page 51 "Language Codes") and press ENTER.

SUBTITLE

Selects the preferred subtitle language for DVD playback.

- Default setting: **OFF**

DISC MENU

Selects the preferred disc menu language for DVD playback.

- Default setting: **ENGLISH**

Use the ▲/▼ keys to select a language and press **ENTER** to confirm.



Note

- For some discs, selection can be made using the DVD menu. In this case, press **MENU** to display the DVD menu screen and then make your selection.

PARENTAL

- Default setting: **8 ADULT**

Some DVDs may have a parental level assigned to the complete disc or to certain scenes on the disc. This feature lets you set a playback limitation level.

The rating levels are from 1 to 8 and are country dependent. You can prohibit the playing of certain discs that are not suitable for your children or play certain discs with alternative scenes for certain discs.

PREFERENCE PAGE	
AUDIO	1 KID SAFE
SUBTITLE	2 G
DISC MENU	3 PG
PARENTAL	4 PG 13
PBC	5 PGR
MP3/JPEG NAV	6 R
VR LIST	7 NC 17
DIVX SUBTITLE	8 ADULT
DEFAULT	

- 1 Press ▲/▼ to highlight a rating level for the disc inserted and press **ENTER**.

- To disable parental controls and have all discs play, select **8 ADULT**.

- 2 Use the numeric keypad (0-9) to enter the six-digit password (see page 49).

- DVDs that are rated above the level you selected will not play unless you enter the six-digit password.



Note

- VCD, SVCD, and CD have no level indication, so the parental control function has no effect with these types of discs. This also applies to most illegal DVD discs.
- Some DVDs are not encoded with a rating even though the movie rating may be printed on the disc cover. The rating level feature does not work for such discs.

PBC

- Default setting: **ON**

The Play Back Control feature is applicable for VCD/SVCD only. It allows you to play Video CDs (2.0) interactively, following the menu on the display.

- **ON** – The index menu (if available) will appear on the TV when you load a VCD/SVCD.
- **OFF** – The VCD/SVCD will skip the index menu and playback directly from the beginning.

MP3/JPEG NAV

- Default setting: **WITHOUT MENU**

MP3/JPEG Navigator can only be set if the disc is recorded with a menu. It allows you to select different display menus for easy navigation.

- **WITHOUT MENU** – Displays all the files contained in the MP3/Picture disc.
- **WITH MENU** – Displays the folder menu of the MP3/Picture disc.



Note

- This DVD system can only display 650 files/folder in the directory.

VR LIST

- Default setting: **ORIGINAL LIST**

There are two ways to play back a disc in VR (Video Recording) format: **ORIGINAL LIST** and **PLAY LIST**. This feature is not available with non-VR format discs.

- **ORIGINAL LIST** – Select this to play the originally recorded titles on the disc.
- **PLAY LIST** – Select this to play the edited version of the disc. This feature is only available when a play list has been created.

Previewing VR format

- 1 During playback, press **SCAN**.
- 2 Press **▲/▼** to highlight either **TITLE DIGEST** or **TITLE INTERVAL**.

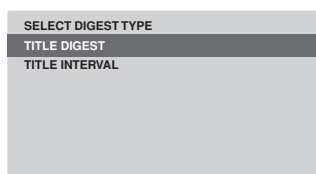

- 3 Press **ENTER** to select the function.

- **TITLE DIGEST** – This function will display thumbnail pictures of titles on the screen. Up to six thumbnail pictures per page will be displayed.
 - In **ORIGINAL LIST** mode, the originally recorded titles on the disc will be displayed.
 - In **PLAY LIST** mode, every title in the play list will be displayed.
- **TITLE INTERVAL** – This function will divide and display the contents of each title being played back in regular intervals, making it easy to preview the recording. Up to six thumbnail pictures per page will be displayed.
 - If the title being played back is short, the **TITLE DIGEST** function will be performed instead.



(example for 6 thumbnail pictures display)

- 4 Use **◀/▶/▲/▼** to select a title, or use the numeric buttons to enter the title number next to **SELECT**.
 - Press **◀◀/▶▶** to access the previous/next page.
- 5 Press **ENTER** to confirm the selection.

To quit the preview function

 - Use **◀/▶/▲/▼** to highlight **EXIT** and press **ENTER** to confirm.

To return to the preview menu

 - Use **◀/▶/▲/▼** to highlight **MENU** and press **ENTER** to confirm.

PASSWORD

The password is used for both Parental Control and Disc Lock. Enter your six-digit password to play a locked disc or when prompted for a password. The default password is "111111". To change the password:

- 1 Press **ENTER** to access the change password menu.

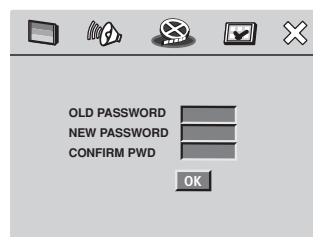

- 2 Use the numeric keypad **0-9** on the remote control to enter your existing six-digit password at **OLD PASSWORD**.

Note

- When doing this for the first time or if you forget your existing password, key in "111111".

- 3 Enter the new six-digit password at **NEW PASSWORD**.
- 4 Enter the new six-digit password again at **CONFIRM PWD**.
- 5 Press **ENTER** to confirm and exit the menu.

DIVX SUBTITLE

You can set the font type that supports the recorded DivX subtitle.

- Default setting: **STANDARD**

STANDARD

Albanian, Danish, Dutch, English, Finnish, French, Gaelic, German, Italian, Kurdish (Latin), Norwegian, Portuguese, Spanish and Swedish.

CYRILLIC

Bulgarian, Belorussian, Macedonian, Moldavian, Russian, Serbian and Ukrainian.

Note

- Supported subtitle extensions for DivX are ".srt", ".smi", ".sub", ".ssa", ".ass".

DEFAULT

This feature enables you to reset all the setup menu options and your personal settings to the factory defaults, except your password for Parental Control and Disc Lock. Press **ENTER** to confirm the default reset.

Language Codes

This page is used to select other languages. This does not affect the options in AUDIO, SUBTITLE or DISC MENU.

Abkhazian	6566
Afar	6565
Afrikaans	6570
Albanian	8381
Amharic	6577
Arabic	6582
Armenian	7289
Assamese	6583
Avestan	6569
Aymara	6589
Azerbaijani	6590
Bashkir	6665
Basque	6985
Belarusian	6669
Bengali	6678
Bihari	6672
Bislma	6673
Bokmål, Norwegian	7866
Bosnian	6683
Breton	6682
Bulgarian	6671
Burmese	7789
Castilian, Spanish	6983
Catalan	6765
Chamorro	6772
Chechen	6769
Chewa; Chichewa; Nyanja	7889
Chichewa; Chewa; Nyanja	7889
Chinese	9072
Chuang; Zhuang	9065
Church Slavic; Slavonic;	6785
Church Slavonic; Church	6785
Chuvash	6786
Cornish	7587
Corsican	6779
Croatian	7282
Czech	6783
Danish	6865
Dutch	7876
Dzongkha	6890
English	6978
Esperanto	6979
Estonian	6984
Faroese	7079
Fijian	7074
Finnish	7073
French	7082
Frisian	7089
Gaelic; Scottish Gaelic	7168
Gallegan	7176
Georgian	7565
German	6869
Gikuyu; kikuyu	7573
Greek	6976
Guarani	7178
Gujarati	7185
Hausa	7265
Hebrew	7269
Herero	7290
Hindi	7273
Hiri Motu	7279
Hungarian	7285
Icelandic	7383

Ido	7379
Indonesian	7368
Interlingua (International)	7365
Interlingue	7369
Inuktitut	7385
Inupiaq	7375
Irish	7165
Italian	7384
Japanese	7465
Javanese	7486
Kalaallisut	7576
Kannada	7578
Kashmiri	7583
Kazakh	7575
Khmer	7577
Kikuyu; Gikuyu	7573
Kinyarwanda	8287
Kirghiz	7589
Komi	7586
Korean	7579
Kuanyama; Kwanyama	7574
Kurdish	7585
Kwanyama; Kuanyama	7574
Lao	7679
Latin	7665
Latvian	7686
Letzeburgesch;	7666
Limburgan; Limburger;	7673
Limburger; Kimburgan;	7673
Limburgish; Limburger;	7673
Lingala	7678
Lithuanian	7684
Luxembourgish;	7666
Macedonian	7775
Malagasy	7771
Malay	7783
Malayalam	7776
Maltese	7784
Manx	7186
Maori	7773
Marathi	7782
Marshallese	7772
Moldavian	7779
Mongolian	7778
Nauru	7865
Navaho; Navajo	7886
Navajo; Navaho	7886
Ndebele; North	7868
Ndebele; South	7882
Ndonga	7871
Nepali	7869
Northern Sami	8369
North Ndebele	7868
Norwegian	7879
Norwegian Bokmål; Bokmål	7866
Norwegian Nynorsk	7878
Nyanja; Chichewa; Chewa	7889
Nynorsk; Norwegian;	7878
Occitan (post 1500); Proven	7967
Old Bulgarian; Old Slavonic;	6785
Old Church Slavonic; Old	6785
Old Slavonic; Church	6785
Oriya	7982

Oromo	7977
Ossetian; Ossetic	7983
Ossetic; Ossetian	7983
Pali	8073
Panjabi	8065
Persian	7065
Polish	8076
Portuguese	8084
Provençal; Occitan (post)	7967
Pushto	8083
Quechua	8185
Raeto-Romance	8277
Romanian	8279
Rundi	8278
Russian	8285
Samoaan	8377
Sango	8371
Sanskrit	8365
Sardinian	8367
Scottish Gaelic; Gaelic	7168
Serbian	8382
Shona	8378
Sindhi	8368
Sinhalese	8373
Slovak	8375
Slovenian	8376
Somali	8379
Sotho, Southern	8384
South Ndebele	7882
Spanish; Castilian	6983
Sundanese	8385
Swahili	8387
Swati	8383
Swedish	8386
Tagalog	8476
Tahitian	8489
Tajik	8471
Tamil	8465
Tatar	8484
Telugu	8469
Thai	8472
Tibetan	6679
Tigrinya	8473
Tonga (Tonga Islands)	8479
Tsonga	8483
Tswana	8478
Turkish	8482
Turkirmen	8475
Twi	8487
Uighur	8571
Ukrainian	8575
Urdu	8582
Uzbek	8590
Vietnamese	8673
Volapük	8679
Walloon	8765
Welsh	6789
Wolof	8779
Xhosa	8872
Yiddish	8973
Yoruba	8979
Zhuang; Chuang	9065
Zulu	9085

Handling discs

When holding discs of any type, take care not to leave fingerprints, dirt or scratches on the disc surface. Hold the disc by its edge or by the center hole and edge.



Damaged or dirty discs can affect playback performance. Take care also not to scratch the label side of the disc. Although not as fragile as the recorded side, scratches can still result in a disc becoming unusable.

Should a disc become marked with fingerprints, dust, etc., clean using a soft, dry cloth, wiping the disc lightly from the center to the outside edge as shown in the diagram below.



Wipe lightly from the center of the disc using straight strokes.

Don't wipe the disc surface using circular strokes.

If necessary, use a cloth moistened in alcohol, or a commercially available CD/DVD cleaning kit to clean a disc more thoroughly. Never use benzene, thinner or other cleaning agents, including products designed for cleaning vinyl records.

Storing discs

Although CDs and DVD discs are more durable than vinyl records, you should still take care to handle and store discs correctly. When you're not using a disc, return it to its case and store upright. Avoid leaving discs in excessively cold, humid, or hot environments (including under direct sunlight).

Don't glue paper or put stickers onto the disc, or use a pencil, ball-point pen or other sharp-tipped writing instrument. These could all damage the disc.



For more detailed care information, see the instructions that come with discs.

Do not load more than one disc into the player.

Discs to avoid

Discs spin at high speed inside the player. If you can see that a disc is cracked, chipped, warped, or otherwise damaged, don't risk using it in your player. You could end up damaging the unit.

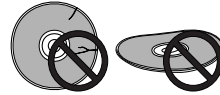

This unit is designed for use with conventional, fully circular discs only. Use of shaped discs is not recommended for this product.

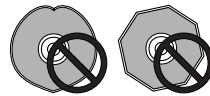

Cleaning the pickup lens

The DVD player's lens should not become dirty in normal use, but if for some reason it should malfunction due to dust or dirt, consult your nearest MARANTZ-authorized service center. Although lens cleaners for CD players are commercially available, we do not recommend using them since some may damage the lens.

Problems with condensation

Condensation may form inside the player if it is brought into a warm room from outside, or if the temperature of the room rises quickly. Although the condensation won't damage the player, it may temporarily impair its performance. For this reason you should leave it to adjust to the warmer temperature for about an hour before switching on and using it.

Hints on installation

We want you to enjoy using this unit for years to come, so please bear in mind the following points when choosing a suitable location for it:

Do...

- ✓ Use in a well-ventilated room.
- ✓ Place on a solid, flat, level surface, such as a table, shelf or stereo rack.

Don't...

- ✗ Use in a place exposed to high temperatures or humidity, including near radiators and other heat-generating appliances.
- ✗ Place on a window sill or other place where the player will be exposed to direct sunlight.
- ✗ Use in an excessively dusty or damp environment.
- ✗ Place directly on top of an amplifier, or other component in your stereo system that becomes hot during use.
- ✗ Use near a television or monitor as you may experience interference, especially if the television uses an indoor antenna.
- ✗ Use in a kitchen or other room where the player may be exposed to smoke or steam.
- ✗ Use on a thick rug or carpet, or cover with cloth: this may prevent proper cooling of the unit.
- ✗ Place on an unstable surface, or one that is not large enough to support all four of the unit's feet.

Moving the player

If you need to move the player, first press the **POWER ON/STANDBY** button on the front panel to put the player in standby, then unplug the power cord. Never lift or move the unit during playback: discs rotate at high speed and may be damaged.

Precautions on using the power cord

Handle the power cord by the plug part. Do not pull out the plug by tugging the cord, and never touch the power cord when your hands are wet, as this could cause a short circuit or electric shock. Do not place the unit, a piece of furniture, or other object on the power cord or pinch the cord in any other way. Never make a knot in the cord or tie it with other cords. The power cords should be routed so that they are not likely to be stepped on. A damaged power cord can cause a fire or give you an electric shock. Check the power cord once in a while. If you find it damaged, ask your nearest MARANTZ authorized service center or your dealer for a replacement.

Troubleshooting

Incorrect operation is often mistaken for trouble or malfunction. If you think that there is something wrong with this unit, check the points below. Sometimes the trouble may lie in another component. Inspect the other components and electrical appliances being used. If the trouble cannot be rectified after checking the items below, ask your nearest MARANTZ authorized service center or your dealer to carry out repair work.

The disc is ejected automatically after loading.

- Dirty or damaged disc.
See **page 52** for disc care information.
- Disc not seated properly in the disc guide.
Align the disc properly.
- Incompatible region number.
If the region number on a DVD-Video disc does not match the number on the player, the disc cannot be used (**page 9**).
- Condensation inside the player.
Allow time for condensation to evaporate. Avoid using the player near an air-conditioning unit.

Playback is not possible.

- Disc is loaded upside down.
Reload the disc with the label side face-up.

Cannot play DVD-R/RW disc.

- Only a DVD-R/RW disc that has been finalized only can be played.

⊘ mark appears on the screen.

- The operation is prohibited by the player.
- The selected function does not operate for that disc.

Picture playback stops and the operation buttons can not be used.

- Press ■ (STOP), then start playback again ► (PLAY).
- Switch to standby once using the front panel POWER ON/STANDBY and then switch on again using the front panel POWER ON/STANDBY.

New settings made in the Setup screen menus while a disc is playing are ineffective.

- Some settings can be changed while a disc is playing, but do not take effect until the disc is stopped then restarted. This is not a malfunction.
Make the same setting when the player is stopped.
Press ■ (STOP), then restart playback ► (PLAY).
Note that making settings in the Setup screen menus may cancel the RESUME function.

Settings are canceled.

- When the power is cut due to a power failure or by unplugging the power cord, settings will be canceled.
Before unplugging the power cord, press the POWER button on the remote control and check that the STANDBY indicator on the front panel is lit.

No picture/No color.

- Incorrect video connections.
Check that connections are correct and that plugs are inserted fully.
- TV/monitor or AV amplifier settings are incorrect.
Check the instruction manual of the connected equipment.
- The PROGRESSIVE menu is set to ON but your TV/monitor is not compatible with progressive scan.
Reconnect the player to your TV using a composite or S-Video cord and set the TV to the appropriate input. Now choose the Interlace setting in the PROGRESSIVE menu, then switch the TV input back to the component input. (**page 43**)

Screen is stretched or aspect does not change.

- The TV ASPECT setting in the Setup menu is incorrect.
Set the TV ASPECT option to match the TV/monitor you're using (**page 43**).

Picture disturbance during playback or dark.

- This player is compatible with Macro-Vision System copy guard. Some discs include a copy prevention signal, and when this type of disc is played back, stripes etc., may appear on some sections of the picture depending on the TV. This is not a malfunction.
- Discs respond differently to particular player functions. This may result in the screen becoming black for a brief instant or shaking slightly when the function is executed.
These problems are largely due to differences between discs and disc content and are not malfunctions of this player.
- When using progressive-scan
If your TV is connected using the COMPONENT VIDEO OUT jacks, set the PROGRESSIVE menu to OFF (**page 43**).

When recorded on a VCR or passed through an AV selector, there is disturbance in the playback picture.

- Due to the player's copy protection circuits, connection of this device through a VCR or an AV selector may prevent recording or cause picture problems. This is not a malfunction.

The remote control doesn't seem to work.

- The remote control is too far from the player, or the angle with the remote sensor is too wide.
Use the remote control within its operating range (page 7).
- The batteries are exhausted.
Put in new batteries (page 7).

Cannot listen to high-sampling rate audio through the digital output.

- **LPCM Out** is set to **48 kHz**.
Set it to **96 kHz**.
- As a copy-protection measure, some DVDs do not output 96 kHz audio.
In this case, even if **96 kHz** is selected, the player automatically outputs the audio at 48 kHz. This is not a malfunction.

No audio, or audio is distorted.

- Some DVD discs do not output digital audio.
Switch your amplifier to the player's analog outputs.
- Dirt, dust, etc. on the disc.
Clean the disc (page 52).
- Interconnectors are not fully inserted into the terminals (or are not connected).
Check that all interconnectors are firmly inserted.
- Dirty or oxidized plugs/terminals.
Clean the plugs/terminals.
- Incorrect audio cable connection.
Check the audio connections (pages 10 to 12).
- Player's output is connected to the amplifier's phono (turntable) inputs.
Connect to any set of inputs *except* phono.
- The disc is paused.
Press ► (**PLAY**) to exit the pause mode.
- Incorrect amplifier settings.
Check that the volume is turned up, that the speakers are on, the input function set correctly, etc.

The analog audio is OK, but there appears to be no digital audio signal.

- Incorrect **AUDIO SETUP** menu settings.
Make sure that the **DIGITAL OUT** setting is set to **ALL** or **PCM** (page 39).
Check the amp's instruction manual.

Noticeable difference in DVD and CD volume.

- DVDs and CDs use different recording methods. This is not a malfunction.

Cannot output 192 kHz or 176.4 kHz digital audio.

The player does not output digital audio at these sampling rates.

Cannot output 96 kHz or 88.2 kHz digital audio.

- Check that the **LPCM OUT** setting is not set to **96 kHz** (page 39).
- Some discs are digital copy-protected and do not output high sampling rate digital audio.

No DTS audio output.

- If this unit is connected to a non-DTS compatible amplifier or decoder using a digital audio cable, set **DIGITAL OUT** to **PCM** in the Setup menu. If you do not do this, noise will be output if you try and play a DTS disc.
- If this unit is connected to a DTS-compatible amplifier or decoder using a digital audio cable, check the amplifier settings, and that the cable is properly connected.

A disc containing the MP3 tracks won't play.

- If the disc is a recordable CD, make sure that the disc had been finalized.
Check that the track(s) are in the MPEG1 Audio Layer 3 format.

Some MP3 tracks appear to be missing from a disc.

- If a track name does not end in ".mp3" or ".MP3", this player will not recognize it as an MP3 track.
- This player only recognizes about 650 files per folder and 300 folders per disc. If there are more titles than this, you will not be able to play them.
- This player is not compatible with multi-session discs. If the disc is multi-session, you will only be able to play tracks recorded onto the first session.

The unit is connected to an HDMI/DVI component but the HDMI/DVI indicator on the display does not light.

- Set the input selector on the connected TV or HDMI/DVI component to this unit.
- This unit cannot be connected to TVs or HDMI/DVI components that do not support HDCP.
- Reset this unit and the TV or HDMI/DVI component by turning them off and on.

No video appears on the connected HDMI/DVI component.

- Can the connected TV or HDMI/DVI component use the selected resolution?
Set the **HDMI VIDEO** under **HDMI Setup**. (page 45)
- Set the input selector on the connected TV or HDMI/DVI component to this unit.
- TVs or HDMI/DVI components that do not support HDCP cannot output video from this unit.

No audio is coming from the connected HDMI component.

- The unit will not output an audio signal if **Audio** has been turned off under **HDMI AUDIO OUT Setup**. (page 39)
- Some HDMI-compatible monitors do not support audio output.
- The unit will not output an audio signal if a DVI component has been connected.

Unable to play DivX movies.

- Check that the DivX files are encoded with "Home Theater's mode with DivX" certified encoder.

No sound during DivX movies playback.

- The audio codes may not be supported by the DVD player.

A DivX movie does not repeat.

- Check that file size of the movies does not exceed the file size of the CD disc during burning.

Specifications

General

System
 DVD-Video, DVD-Audio, DVD±R/RW, Super Audio CD, Video CD, CD, MP3 files, JPEG files, DviX and WMA
 Power requirements (U.S.A.) 120 V, 60Hz
 Power requirements (Europe) 230 V, 50/60Hz
 Power consumption 25 W
 Power consumption in standby mode 0.8 W
 Weight 4 kg (8 lb 13 oz)
 Dimensions 440 (W) x 60 (H) x 319 (D) mm
 (17.3 (W) x 2.4 (H) x 12.6 (D) in.)
 Operating temperature
 +5 °C to +35 °C (+41 °F to +96 °F)
 Operating humidity
 5 % to 85 % (no condensation)

S-Video output

Y (luminance) - Output level 1 Vp-p (75 Ω)
 C (color) - Output level 286 mVp-p (75 Ω)
 Jacks S-VIDEO jack

Video output

Output level 1 Vp-p (75 Ω)
 Jacks RCA jack

Component video output (Y, C_B, C_R)

Output level Y: 1.0 Vp-p (75 Ω)
 C_B/P_B, C_R/P_R: 0.7 Vp-p (75 Ω)
 Jacks RCA jacks

HDMI output

Output terminal 19-pin

21-pin connector assignment
 (Europe model only)

AV connector output 21-pin connector
 This connector provides the video and audio signals for connection to a compatible color TV or monitor.

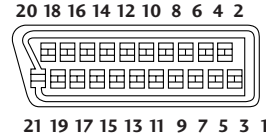

PIN no.	
1	Audio 2/R out 15 R out
3	Audio 1/L out 16 Blank
4	GND 17 GND
7	B out 19 Video out
8	Status 21 GND
11	G out

Audio output

Output level
 During audio output 2 Vrms (1 kHz, 0 dB)
 Number of channels 2/6
 Jacks RCA jack

Audio characteristics

Frequency response
 4 Hz to 44 kHz (DVD fs: 96 kHz)
 S/N ratio 110 dB
 Dynamic range 100 dB
 Total harmonic distortion 0.003 %
 Wow and flutter: Limit of measurement (±0.001 % W. PEAK) or lower

Digital output

Coaxial digital output RCA jack
 Optical digital output Optical digital jack

Other terminals

Control in/out RCA jack
 Flasher input Mini jack (3.5ø)
 RS232C 1

Accessories

Remote control 1
 AAA/R03 dry cell batteries 2
 Audio/Video cable (yellow/red/white) 1
 System control cable 1
 Power cable 1
 User Guide (this manual)
 Warranty card

Note: The specifications and design of this product are subject to change without notice, due to improvement.

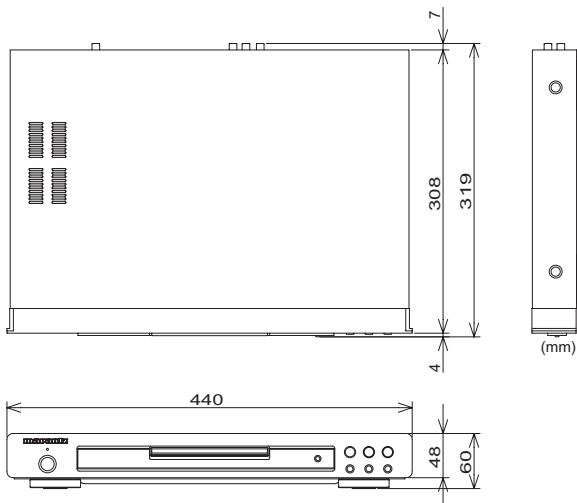

www.marantz.com

You can find your nearest authorized distributor or dealer on our website.

marantz[®] is a registered trademark.



Printed in XXXXX

2006/XX PMC

00M19CW851250